

International IOR Rectifier

12CWQ06FN

SCHOTTKY RECTIFIER

12 Amp



Major Ratings and Characteristics

Characteristics	12CWQ06FN	Units
$I_{F(AV)}$ Rectangular waveform	12	A
V_{RRM}	60	V
I_{FSM} @ $t_p = 5 \mu s$ sine	320	A
V_F @ 6 Apk, $T_J = 125^\circ C$ (per leg)	0.57	V
T_J range	-55 to 150	$^\circ C$

Description/ Features

The 12CWQ06FN surface mount, center tap, Schottky rectifier series has been designed for applications requiring low forward drop and small foot prints on PC board. Typical applications are in disk drives, switching power supplies, converters, free-wheeling diodes, battery charging, and reverse battery protection.

- Popular D-PAK outline
- Center tap configuration
- Small foot print, surface mountable
- Low forward voltage drop
- High frequency operation
- Guard ring for enhanced ruggedness and long term reliability

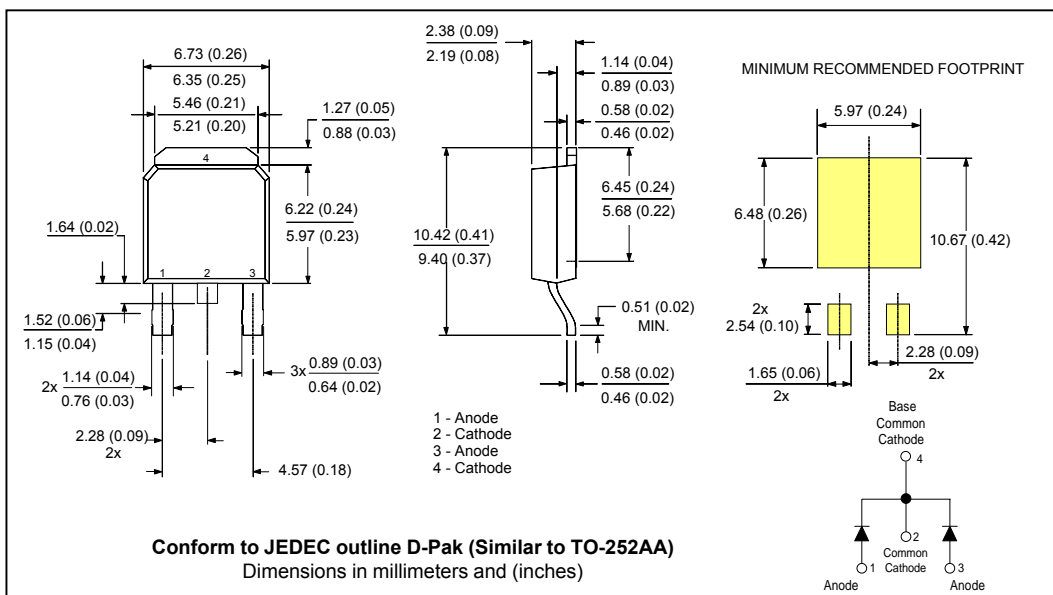

Voltage Ratings

Part number	12CWQ06FN
V_R Max. DC Reverse Voltage (V)	60
V_{RWM} Max. Working Peak Reverse Voltage (V)	

Absolute Maximum Ratings

Parameters	12CWQ...	Units	Conditions
$I_{F(AV)}$ Max. Average Forward (Per Leg) Current * See Fig. 5 (Per Device)	6	A	50% duty cycle @ $T_C = 131^\circ\text{C}$, rectangular wave form
	12		
I_{FSM} Max. Peak One Cycle Non-Repetitive Surge Current * See Fig. 7	320	A	5 μs Sine or 3 μs Rect. pulse
	105		10ms Sine or 6ms Rect. pulse
E_{AS} Non-Repet. Avalan. Energy (Per Leg)	7	mJ	$T_J = 25^\circ\text{C}$, $I_{AS} = 1.2$ Amps, $L = 10$ mH
I_{AR} Repetitive Avalanche Current (Per Leg)	0.8	A	Current decaying linearly to zero in 1 μsec Frequency limited by T_J max. $V_A = 1.5 \times V_R$ typical

Electrical Specifications

Parameters	12CWQ...	Units	Conditions
V_{FM} Max. Forward Voltage Drop (Per Leg) * See Fig. 1 (1)	0.61	V	@ 6A
	0.79	V	@ 12A
	0.57	V	@ 6A
	0.72	V	@ 12A
I_{RM} Max. Reverse Leakage Current (Per Leg) * See Fig. 2 (1)	3	mA	$T_J = 25^\circ\text{C}$
	35	mA	$T_J = 125^\circ\text{C}$
$V_{F(TO)}$ Threshold Voltage	0.36	V	$T_J = T_J$ max.
r_t Forward Slope Resistance	24.14	m Ω	
C_T Typ. Junction Capacitance (Per Leg)	360	pF	$V_R = 5V_{DC}$, (test signal range 100Khz to 1Mhz) 25°C
L_S Typical Series Inductance (Per Leg)	5.0	nH	Measured lead to lead 5mm from package body

(1) Pulse Width < 300 μs , Duty Cycle < 2%

Thermal-Mechanical Specifications

Parameters	12CWQ...	Units	Conditions
T_J Max. Junction Temperature Range (*)	-55 to 150	$^\circ\text{C}$	
T_{stg} Max. Storage Temperature Range	-55 to 150	$^\circ\text{C}$	
R_{thJC} Max. Thermal Resistance (Per Leg) Junction to Case (Per Device)	3.0	$^\circ\text{C}/\text{W}$	DC operation * See Fig. 4
	1.5		
wt Approximate Weight	0.3(0.01)	g(oz.)	
Case Style	D-Pak		Similar to TO-252AA

(*) $\frac{dP_{tot}}{dT_J} < \frac{1}{R_{th(j-a)}}$ thermal runaway condition for a diode on its own heatsink

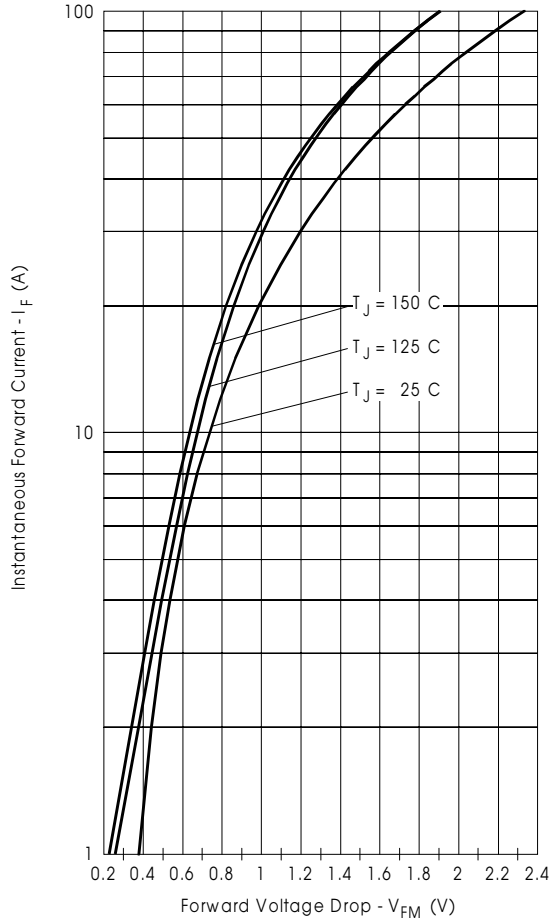

Fig. 1 - Max. Forward Voltage Drop Characteristics (Per Leg)

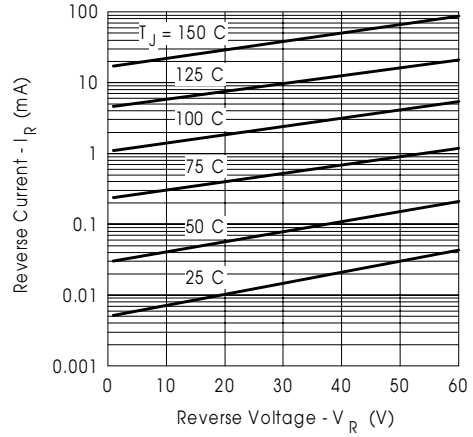

Fig. 2 - Typical Values Of Reverse Current Vs. Reverse Voltage (Per Leg)

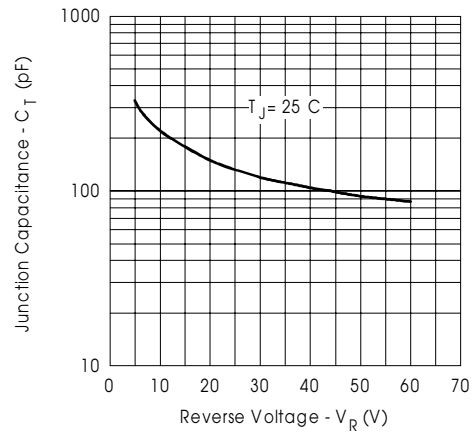

Fig. 3 - Typical Junction Capacitance Vs. Reverse Voltage (Per Leg)

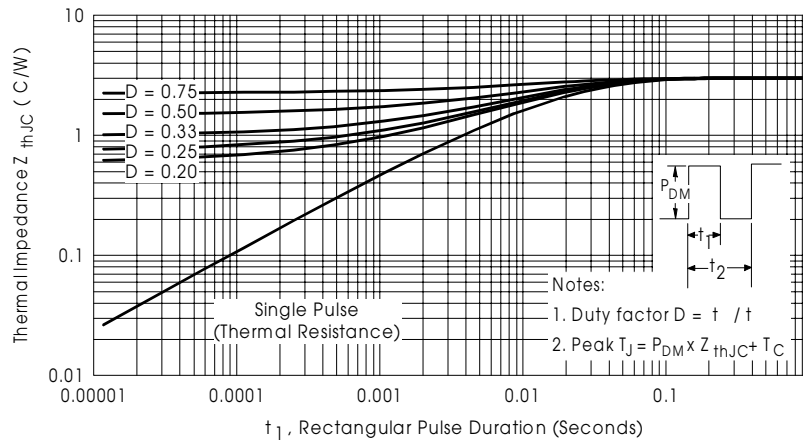

Fig. 4 - Max. Thermal Impedance Z_{thJC} Characteristics (Per Leg)

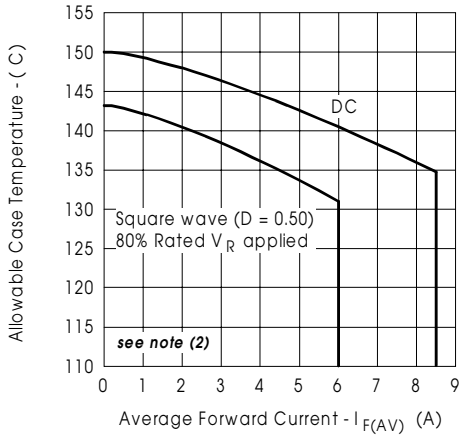

Fig. 5- Max. Allowable Case Temperature Vs. Average Forward Current (Per Leg)

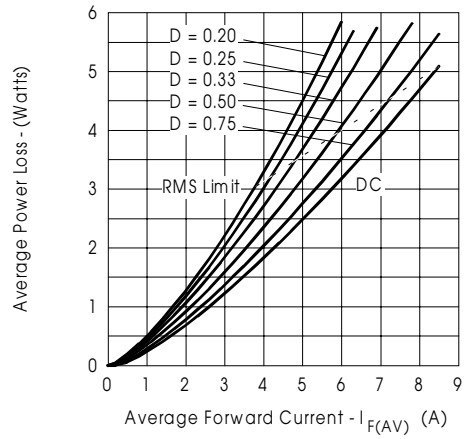

Fig. 6- Forward Power Loss Characteristics (Per Leg)

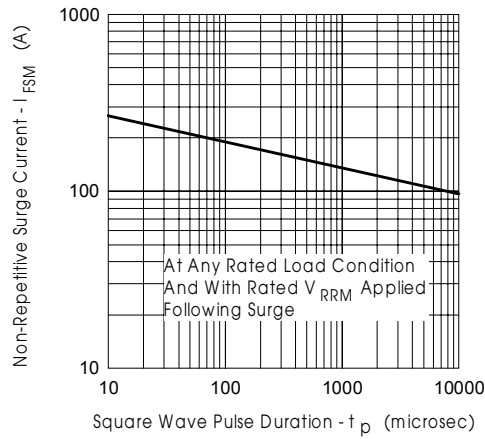

Fig. 7- Max. Non-Repetitive Surge Current (Per Leg)

(2) Formula used: $T_C = T_J - (Pd + Pd_{REV}) \times R_{thJC}$;

Pd = Forward Power Loss = $I_{F(AV)} \times V_{FM} @ (I_{F(AV)} / D)$ (see Fig. 6);

Pd_{REV} = Inverse Power Loss = $V_{R1} \times I_R (1 - D)$; $I_R @ V_{R1} = 80\%$ rated V_R

Marking Information

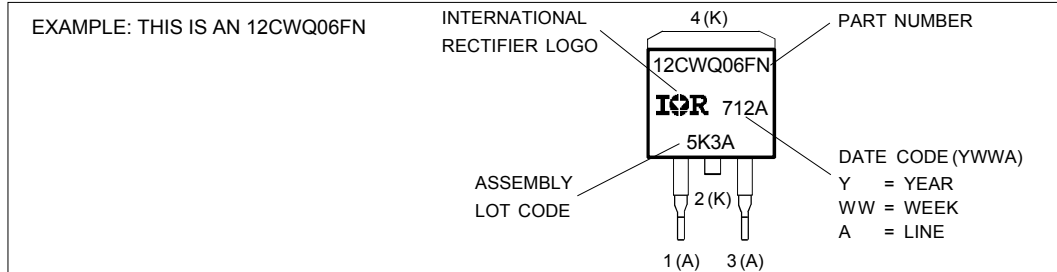

Tape & Reel Information

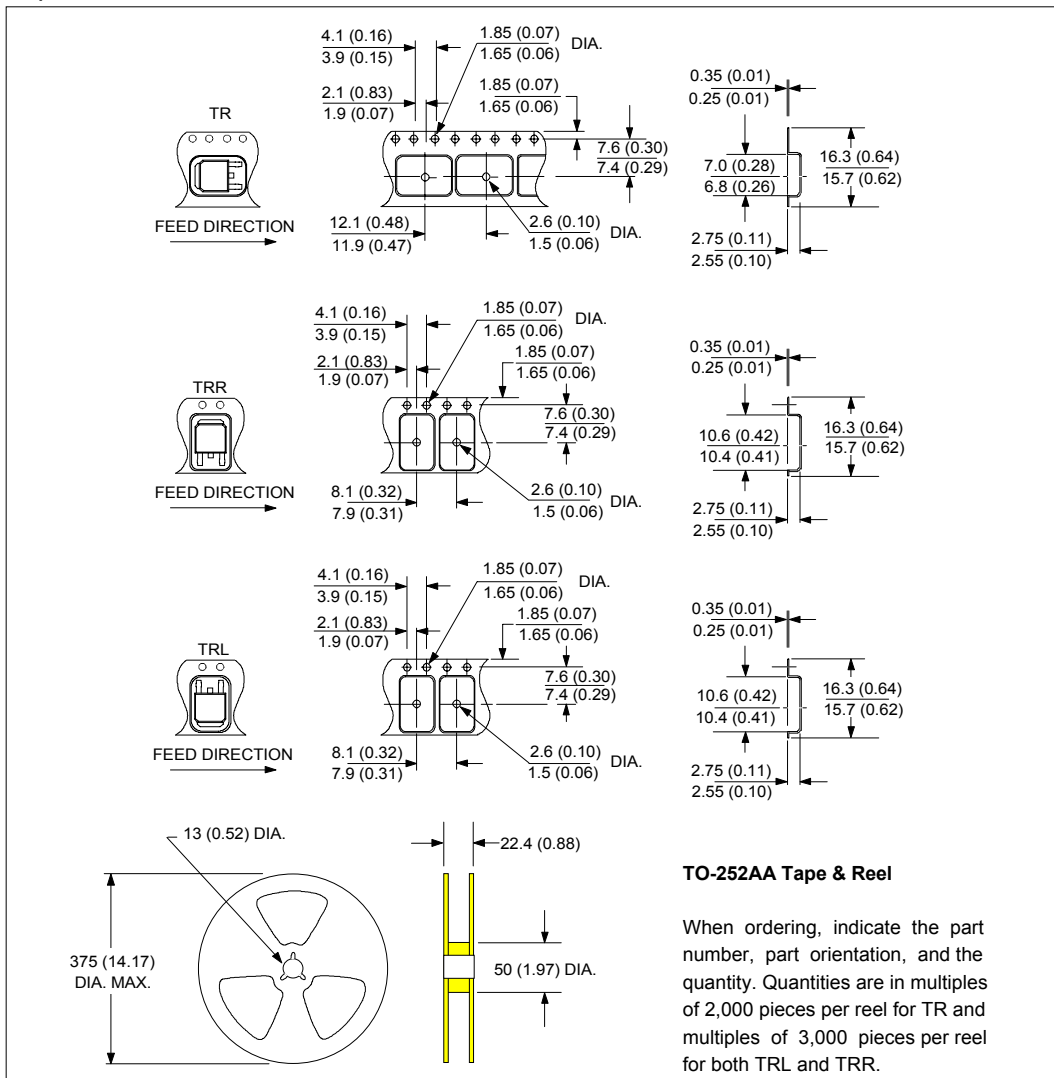

```

12CWQ06FN
*****
* This model has been developed by      *
* Wizard SPICE MODEL GENERATOR (1999) *
* International Rectifier Corporation)  *
* contains Proprietary Information     *
*****
* SPICE Model Diode is composed by a   *
* simple diode plus paralalled VCG2T   *
*****
.SUBCKT 12CWQ06FN ANO CAT
D1 ANO 1 DMOD (0.03191)
*Define diode model
.MODEL DMOD D(IS=8.95944674613071E-05A,N=1.03666612245428,BV=67V,
+ IBV=0.232083097618696A,RS= 0.00089348,CJO=2.04854724822182E-08,
+ VJ=1.34189135485872,XTI=2, EG=0.732501148466477)
*****
*Implementation of VCG2T
VX 1 2 DC 0V
R1 2 CAT TRES 1E-6
.MODEL TRES RES(R=1,TC1=52.5561105683715)
GP1 ANO CAT VALUE={-ABS(I(VX))*(EXP((( -3.507402E-03/52.55611)*(V(2,CAT)*1E6)/
(I(VX)+1E-6)-1))+1)*4.963732E-02*ABS(V(ANO,CAT)))-1}
*****
.ENDS 12CWQ06FN

Thermal Model Subcircuit
.SUBCKT 12CWQ06FN 5 1

CTHERM1 5 4 8.75E-04
CTHERM2 4 3 5.33E+01
CTHERM3 3 2 2.05E+02
CTHERM4 2 1 7.61E+02

RTHERM1 5 4 1.00E-07
RTHERM2 4 3 1.65E+00
RTHERM1 3 2 1.12E+00
RTHERM1 2 1 2.29E-01

.ENDS 12CWQ06FN

```

Data and specifications subject to change without notice.
This product has been designed and qualified for Industrial Level.
Qualification Standards can be found on IR's Web site.

International
IOR Rectifier

IR WORLD HEADQUARTERS: 233 Kansas St., El Segundo, California 90245, USA Tel: (310) 252-7105
TAC Fax: (310) 252-7309
Visit us at www.irf.com for sales contact information. 05/02