

SC16C550

Universal Asynchronous Receiver/Transmitter (UART)
with 16-byte FIFO and infrared (IrDA) encoder/decoder

Rev. 05 — 19 June 2003

Product data

1. General description

The SC16C550 is a Universal Asynchronous Receiver and Transmitter (UART) used for serial data communications. Its principal function is to convert parallel data into serial data, and vice versa. The UART can handle serial data rates up to 3 Mbits/s.

The SC16C550 is pin compatible with the ST16C550, TL16C550 and PC16C550, and it will power-up to be functionally equivalent to the 16C450. Programming of control registers enables the added features of the SC16C550. Some of these added features are the 16-byte receive and transmit FIFOs, automatic hardware or software flow control and Infrared encoding/decoding. The selectable auto-flow control feature significantly reduces software overload and increases system efficiency while in FIFO mode by automatically controlling serial data flow using $\overline{\text{RTS}}$ output and $\overline{\text{CTS}}$ input signals. The SC16C550 also provides DMA mode data transfers through FIFO trigger levels and the $\overline{\text{TXRDY}}$ and $\overline{\text{RXRDY}}$ signals. On-board status registers provide the user with error indications, operational status, and modem interface control. System interrupts may be tailored to meet user requirements. An internal loop-back capability allows on-board diagnostics.

The SC16C550 operates at 5 V, 3.3 V and 2.5 V, and the Industrial temperature range, and is available in plastic DIP40, PLCC44 and LQFP48 packages.

2. Features

- 5 V, 3.3 V and 2.5 V operation
- Industrial temperature range
- After reset, all registers are identical to the typical 16C450 register set
- Capable of running with all existing generic 16C450 software
- Pin compatibility with the industry-standard ST16C450/550, TL16C450/550, PC16C450/550
- Up to 3 Mbits/s transmit/receive operation at 5 V, 2 Mbits/s at 3.3 V, and 1 Mbit/s at 2.5 V
- 16 byte transmit FIFO
- 16 byte receive FIFO with error flags
- Programmable auto- $\overline{\text{RTS}}$ and auto- $\overline{\text{CTS}}$
 - ◆ In auto- $\overline{\text{CTS}}$ mode, $\overline{\text{CTS}}$ controls transmitter
 - ◆ In auto- $\overline{\text{RTS}}$ mode, RxFIFO contents and threshold control $\overline{\text{RTS}}$
- Automatic software/hardware flow control
- Programmable Xon/Xoff characters
- Software selectable Baud Rate Generator
- Four selectable Receive FIFO interrupt trigger levels



PHILIPS

- Standard modem interface or infrared IrDA encoder/decoder interface
- Sleep mode
- Standard asynchronous error and framing bits (Start, Stop, and Parity Overrun Break)
- Independent receiver clock input
- Transmit, Receive, Line Status, and Data Set interrupts independently controlled
- Fully programmable character formatting:
 - ◆ 5-, 6-, 7-, or 8-bit characters
 - ◆ Even-, Odd-, or No-Parity formats
 - ◆ 1-, 1½-, or 2-stop bit
 - ◆ Baud generation (DC to 3 Mbit/s)
- False start-bit detection
- Complete status reporting capabilities
- 3-State output TTL drive capabilities for bi-directional data bus and control bus
- Line Break generation and detection
- Internal diagnostic capabilities:
 - ◆ Loop-back controls for communications link fault isolation
- Prioritized interrupt system controls
- Modem control functions ($\overline{\text{CTS}}$, $\overline{\text{RTS}}$, $\overline{\text{DSR}}$, $\overline{\text{DTR}}$, $\overline{\text{RI}}$, $\overline{\text{DCD}}$).

3. Ordering information

Table 1: Ordering information

Industrial: $V_{CC} = 2.5\text{ V}, 3.3\text{ V}$ or $5\text{ V} \pm 10\%$; $T_{amb} = -40\text{ }^{\circ}\text{C}$ to $+85\text{ }^{\circ}\text{C}$.

Type number	Package		
	Name	Description	Version
SC16C550IA44	PLCC44	plastic leaded chip carrier; 44 leads	SOT187-2
SC16C550IB48	LQFP48	plastic low profile quad flat package; 48 leads; body $7 \times 7 \times 1.4\text{ mm}$	SOT313-2
SC16C550IN40	DIP40	plastic dual in-line package; 40 leads (600 mil)	SOT129-1

4. Block diagram

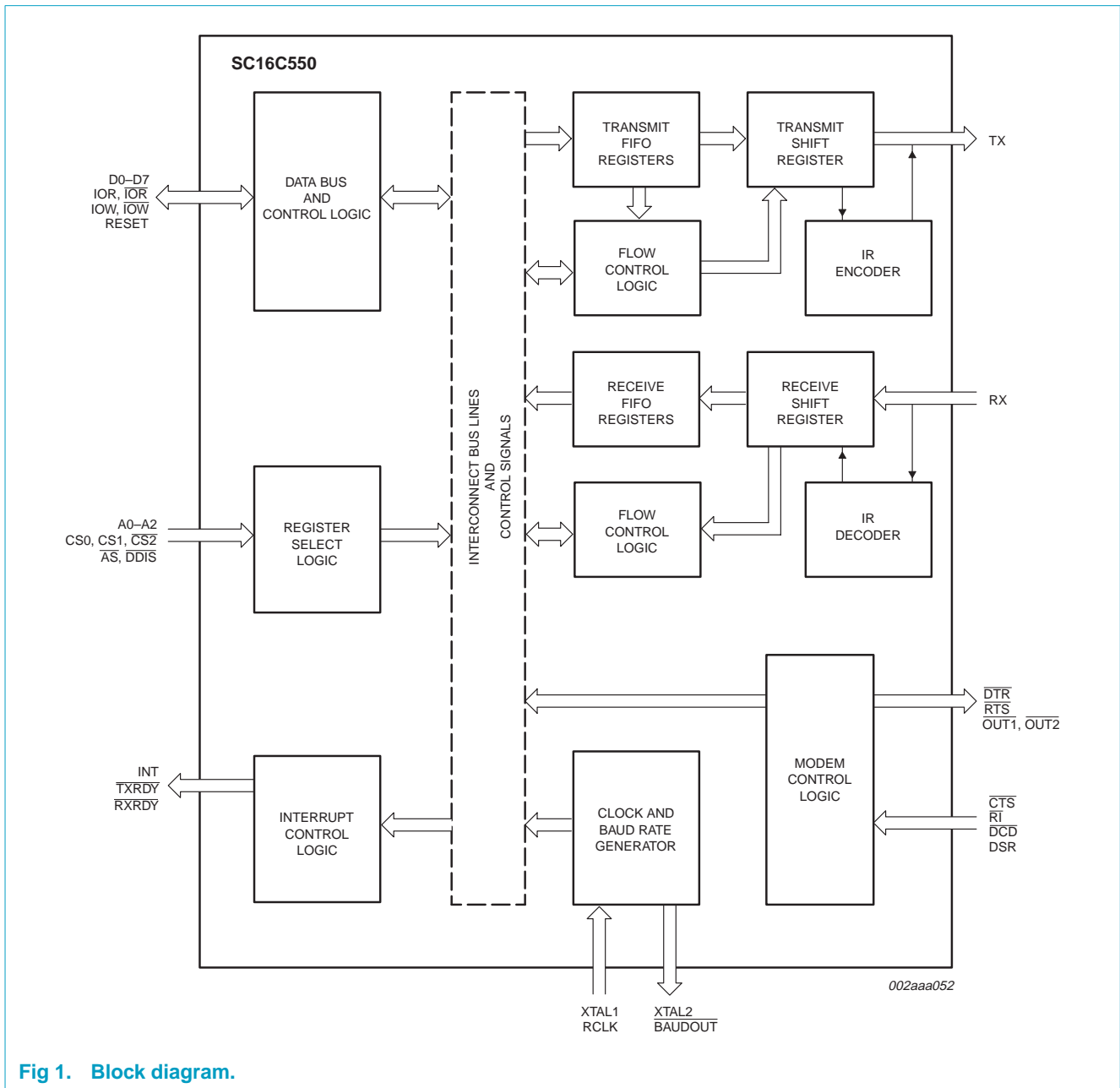

Fig 1. Block diagram.

5. Pinning information

5.1 Pinning

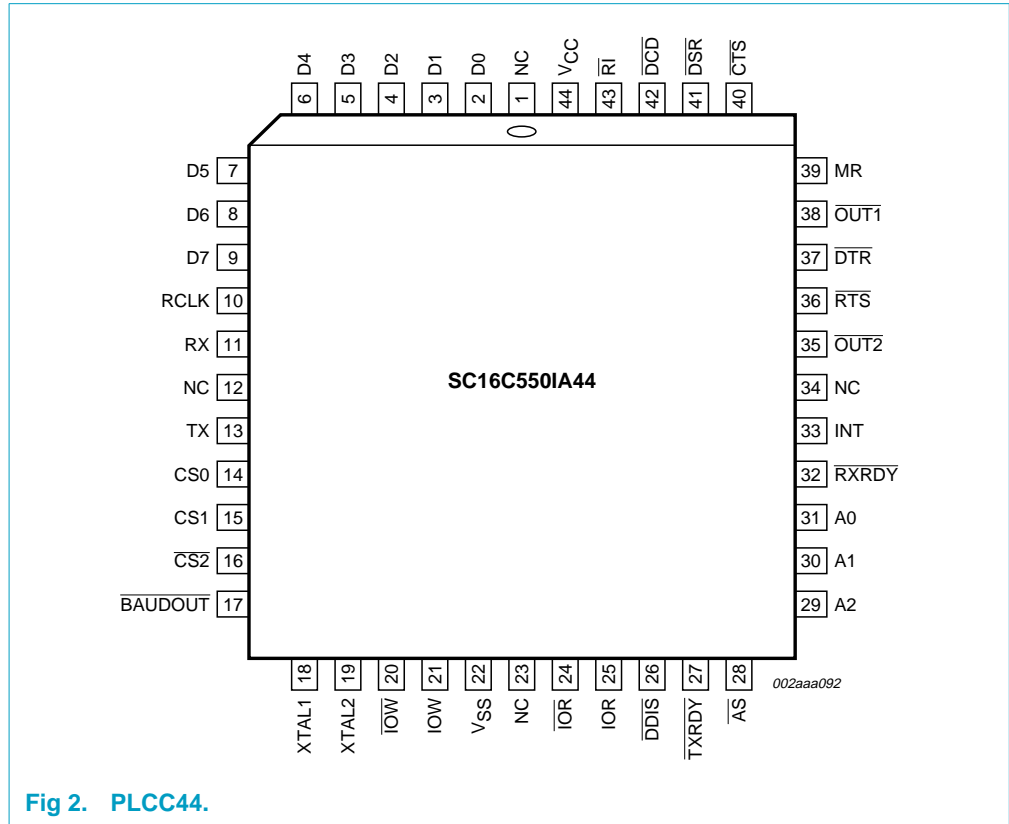

Fig 2. PLCC44.

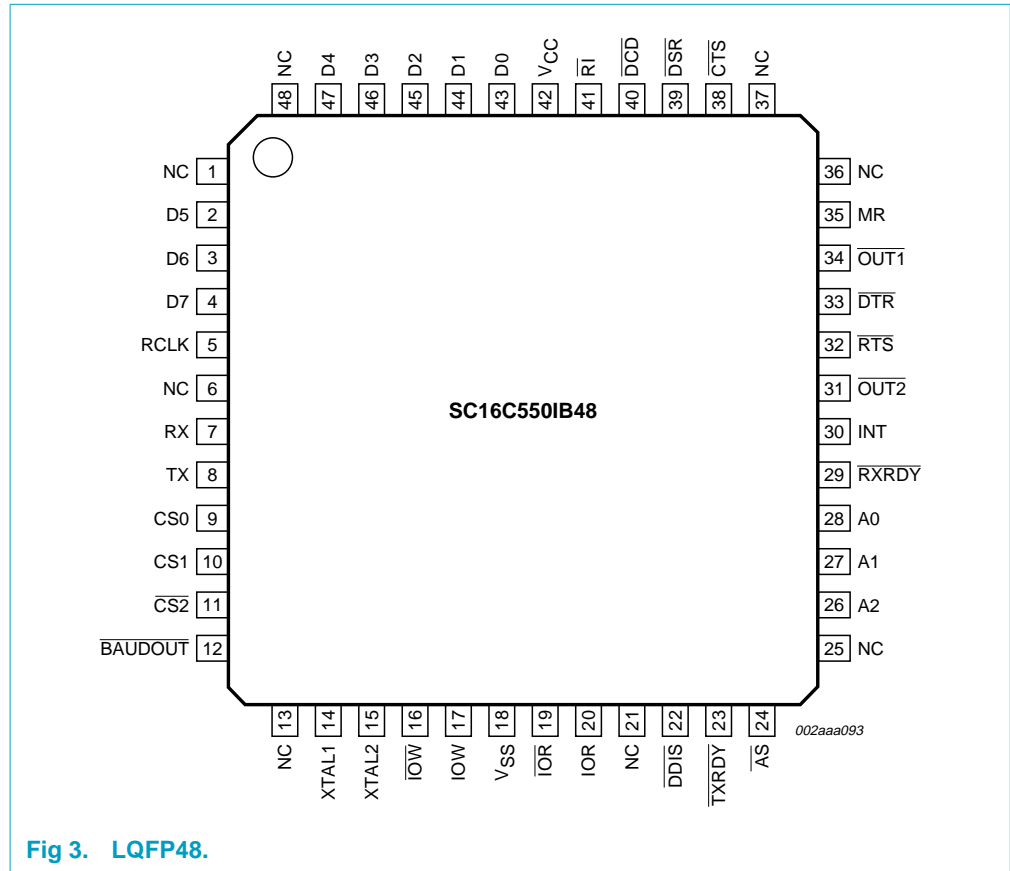

Fig 3. LQFP48.

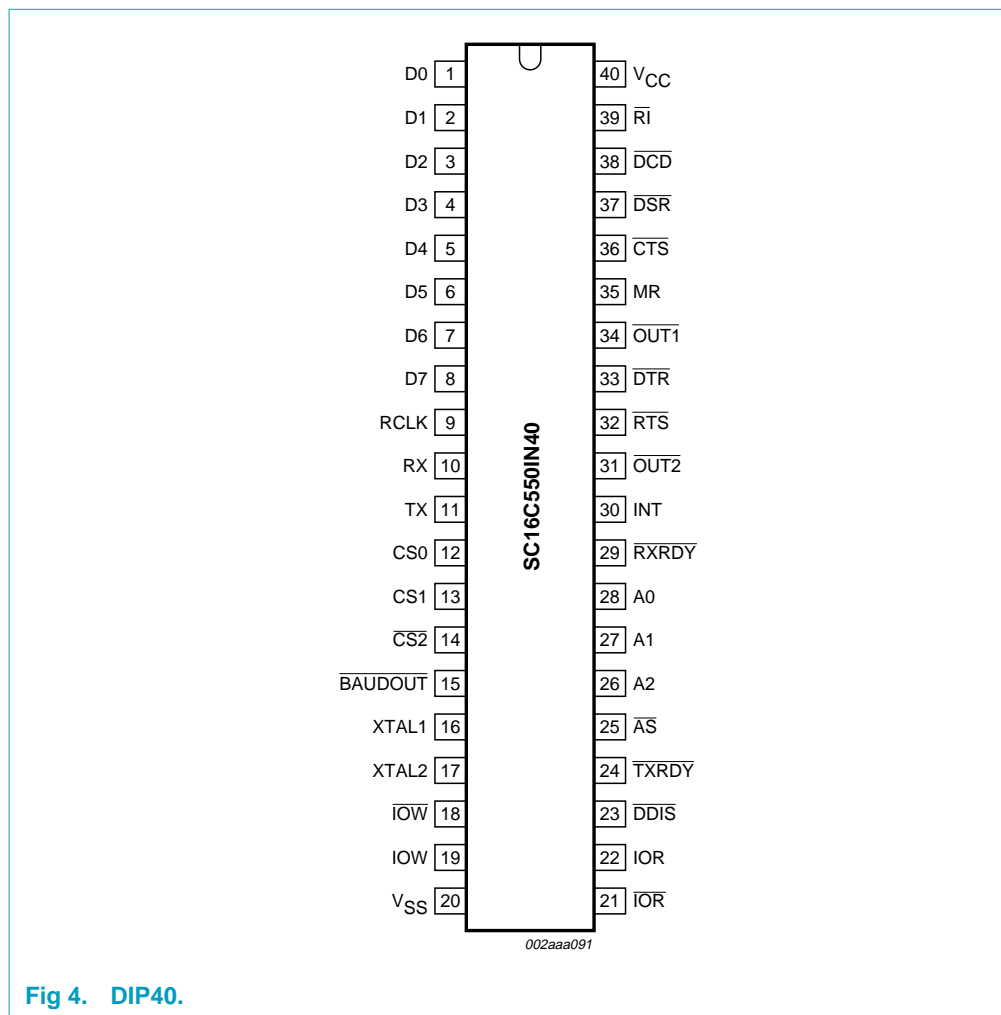

Fig 4. DIP40.

5.2 Pin description

Table 2: Pin description

Symbol	Pin			Type	Description
	PLCC44	LQFP48	DIP40		
A2-A0	28, 27, 26	28, 27, 26	28, 27, 26	I	Register select. A0-A2 are used during read and write operations to select the UART register to read from or write to. Refer to Table 3 for register addresses and refer to AS description.
AS	28	24	25	I	Address strobe. When AS is active (LOW), A0, A1, and A2 and CS0, CS1, and CS2 drive the internal select logic directly; when AS is HIGH, the register select and chip select signals are held at the logic levels they were in when the LOW-to-HIGH transition of AS occurred.
BAUDOUT	17	12	15	O	Baud out. BAUDOUT is a 16× clock signal for the transmitter section of the UART. The clock rate is established by the reference oscillator frequency divided by a divisor specified in the baud generator divisor latches. BAUDOUT may also be used for the receiver section by tying this output to RCLK.

Table 2: Pin description...continued

Symbol	Pin			Type	Description
	PLCC44	LQFP48	DIP40		
CS0, CS1, $\overline{\text{CS2}}$	14, 15, 16	9, 10, 11	12, 13, 14	I	Chip select. When CS0 and CS1 are HIGH and $\overline{\text{CS2}}$ is LOW, these three inputs select the UART. When any of these inputs are inactive, the UART remains inactive (refer to $\overline{\text{AS}}$ description).
$\overline{\text{CTS}}$	40	38	36	I	Clear to send. $\overline{\text{CTS}}$ is a modem status signal. Its condition can be checked by reading bit 4 ($\overline{\text{CTS}}$) of the modem status register. Bit 0 ($\overline{\text{CTS}}$) of the modem status register indicates that $\overline{\text{CTS}}$ has changed states since the last read from the modem status register. If the modem status interrupt is enabled when $\overline{\text{CTS}}$ changes levels and the auto- $\overline{\text{CTS}}$ mode is not enabled, an interrupt is generated. $\overline{\text{CTS}}$ is also used in the auto- $\overline{\text{CTS}}$ mode to control the transmitter.
D7-D0	2-9	43-47, 2-4	8-1	I/O	Data bus. Eight data lines with 3-State outputs provide a bi-directional path for data, control and status information between the UART and the CPU.
$\overline{\text{DCD}}$	42	40	38	I	Data carrier detect. $\overline{\text{DCD}}$ is a modem status signal. Its condition can be checked by reading bit 7 ($\overline{\text{DCD}}$) of the modem status register. Bit 3 ($\overline{\text{DCD}}$) of the modem status register indicates that $\overline{\text{DCD}}$ has changed states since the last read from the modem status register. If the modem status interrupt is enabled when $\overline{\text{DCD}}$ changes levels, an interrupt is generated.
$\overline{\text{DDIS}}$	26	22	23	O	Driver disable. $\overline{\text{DDIS}}$ is active (LOW) when the CPU is not reading data. When active, $\overline{\text{DDIS}}$ can disable an external transceiver.
$\overline{\text{DSR}}$	41	39	37	I	Data set ready. $\overline{\text{DSR}}$ is a modem status signal. Its condition can be checked by reading bit 5 ($\overline{\text{DSR}}$) of the modem status register. Bit 1 ($\overline{\text{DSR}}$) of the modem status register indicates $\overline{\text{DSR}}$ has changed levels since the last read from the modem status register. If the modem status interrupt is enabled when $\overline{\text{DSR}}$ changes levels, an interrupt is generated.
$\overline{\text{DTR}}$	37	33	33	O	Data terminal ready. When active (LOW), $\overline{\text{DTR}}$ informs a modem or data set that the UART is ready to establish communication. $\overline{\text{DTR}}$ is placed in the active level by setting the DTR bit of the modem control register. DTR is placed in the inactive level either as a result of a Master Reset, during loop mode operation, or clearing the DTR bit.
INT	33	30	30	O	Interrupt. When active (HIGH), INT informs the CPU that the UART has an interrupt to be serviced. Four conditions that cause an interrupt to be issued are: a receiver error, received data that is available or timed out (FIFO mode only), an empty transmitter holding register or an enabled modem status interrupt. INT is reset (deactivated) either when the interrupt is serviced or as a result of a Master Reset.
MR	39	35	35	I	Master Reset. When active (HIGH), MR clears most UART registers and sets the levels of various output signals.
NC	1, 12, 23, 34	1, 5, 13, 21, 25, 36, 37, 48	-	-	Not connected.
$\overline{\text{OUT1}}$, $\overline{\text{OUT2}}$	38, 35	34, 31	34, 31	O	Outputs 1 and 2. These are user-designated output terminals that are set to the active (low) level by setting respective modem control register (MCR) bits ($\overline{\text{OUT1}}$ and $\overline{\text{OUT2}}$). $\overline{\text{OUT1}}$ and $\overline{\text{OUT2}}$ are set to inactive the (HIGH) level as a result of Master Reset, during loop mode operations, or by clearing bit 2 ($\overline{\text{OUT1}}$) or bit 3 ($\overline{\text{OUT2}}$) of the MCR.

Table 2: Pin description...continued

Symbol	Pin			Type	Description
	PLCC44	LQFP48	DIP40		
RCLK	10	5	9	I	Receiver clock. RCLK is the 16× baud rate clock for the receiver section of the UART.
$\overline{\text{IOR}}$, IOR	24, 25	19, 20	21, 22	I	Read inputs. When either $\overline{\text{IOR}}$ or IOR is active (LOW or HIGH, respectively) while the UART is selected, the CPU is allowed to read status information or data from a selected UART register. Only one of these inputs is required for the transfer of data during a read operation; the other input should be tied to its inactive level (i.e., IOR tied LOW or $\overline{\text{IOR}}$ tied HIGH).
$\overline{\text{RI}}$	43	41	39	I	Ring indicator. $\overline{\text{RI}}$ is a modem status signal. Its condition can be checked by reading bit 6 ($\overline{\text{RI}}$) of the modem status register. Bit 2 (TERI) of the modem status register indicates that $\overline{\text{RI}}$ has transitioned from a LOW to a HIGH level since the last read from the modem status register. If the modem status interrupt is enabled when this transition occurs, an interrupt is generated.
$\overline{\text{RTS}}$	36	32	32	O	Request to send. When active, $\overline{\text{RTS}}$ informs the modem or data set that the UART is ready to receive data. $\overline{\text{RTS}}$ is set to the active level by setting the $\overline{\text{RTS}}$ modem control register bit and is set to the inactive (HIGH) level either as a result of a Master Reset or during loop mode operations or by clearing bit 1 (RTS) of the MCR. In the auto-RTS mode, $\overline{\text{RTS}}$ is set to the inactive level by the receiver threshold control logic.
$\overline{\text{RXRDY}}$	32	29	29	O	Receiver ready. Receiver direct memory access (DMA) signaling is available with $\overline{\text{RXRDY}}$. When operating in the FIFO mode, one of two types of DMA signaling can be selected using the FIFO control register bit 3 (FCR[3]). When operating in the 16C450 mode, only DMA mode 0 is allowed. Mode 0 supports single-transfer DMA in which a transfer is made between CPU bus cycles. Mode 1 supports multi-transfer DMA in which multiple transfers are made continuously until the receiver FIFO has been emptied. In DMA mode 0 (FCR0 = 0 or FCR0 = 1, FCR3 = 0), when there is at least one character in the receiver FIFO or receiver holding register, $\overline{\text{RXRDY}}$ is active (LOW). When $\overline{\text{RXRDY}}$ has been active but there are no characters in the FIFO or holding register, $\overline{\text{RXRDY}}$ goes inactive (HIGH). In DMA mode 1 (FCR0 = 1, FCR3 = 1), when the trigger level or the time-out has been reached, $\overline{\text{RXRDY}}$ goes active (LOW); when it has been active but there are no more characters in the FIFO or holding register, it goes inactive (HIGH).
RX	11	7	10	I	Serial data input. RX is serial data input from a connected communications device.
TX	13	8	11	I	Serial data output. TX is composite serial data output to a connected communication device. TX is set to the marking (HIGH) level as a result of Master Reset.
$\overline{\text{TXRDY}}$	27	23	24	O	Transmitter ready. Transmitter DMA signaling is available with $\overline{\text{TXRDY}}$. When operating in the FIFO mode, one of two types of DMA signaling can be selected using FCR[3]. When operating in the 16C450 mode, only DMA mode 0 is allowed. Mode 0 supports single-transfer DMA in which a transfer is made between CPU bus cycles. Mode 1 supports multi-transfer DMA in which multiple transfers are made continuously until the transmit FIFO has been filled.

Table 2: Pin description...continued

Symbol	Pin			Type	Description
	PLCC44	LQFP48	DIP40		
V _{CC}	44	42	40	Power	2.5 V, 3.3 V or 5 V supply voltage.
V _{SS}	22	18	20	Power	Ground voltage.
$\overline{\text{IOW}}$, IOW	20, 21	16, 17	18, 19	I	Write inputs. When either $\overline{\text{IOW}}$ or IOW is active (LOW or HIGH, respectively) and while the UART is selected, the CPU is allowed to write control words or data into a selected UART register. Only one of these inputs is required to transfer data during a write operation; the other input should be tied to its inactive level (i.e., IOW tied LOW or $\overline{\text{IOW}}$ tied HIGH).
XTAL1	18	14	16	I	Crystal connection or External clock input.
XTAL2 ^[1]	19	15	17	O	Crystal connection or the inversion of XTAL1 if XTAL1 is driven.

[1] In sleep mode, XTAL2 is left floating.

6. Functional description

The SC16C550 provides serial asynchronous receive data synchronization, parallel-to-serial and serial-to-parallel data conversions for both the transmitter and receiver sections. These functions are necessary for converting the serial data stream into parallel data that is required with digital data systems. Synchronization for the serial data stream is accomplished by adding start and stop bits to the transmit data to form a data character (character orientated protocol). Data integrity is insured by attaching a parity bit to the data character. The parity bit is checked by the receiver for any transmission bit errors. The SC16C550 is fabricated with an advanced CMOS process to achieve low drain power and high speed requirements.

The SC16C550 is an upward solution that provides 16 bytes of transmit and receive FIFO memory, instead of none in the 16C450. The SC16C550 is designed to work with high speed modems and shared network environments that require fast data processing time. Increased performance is realized in the SC16C550 by the larger transmit and receive FIFOs. This allows the external processor to handle more networking tasks within a given time. In addition, the four selectable levels of FIFO trigger interrupt and automatic hardware/software flow control is uniquely provided for maximum data throughput performance, especially when operating in a multi-channel environment. The combination of the above greatly reduces the bandwidth requirement of the external controlling CPU, increases performance, and reduces power consumption.

The SC16C550 is capable of operation up to 3 Mb/s with a 48 MHz external clock input (at 5 V).

The rich feature set of the SC16C550 is available through internal registers. Automatic hardware/software flow control, selectable receive FIFO trigger level, selectable TX and RX baud rates, infrared encoder/decoder interface, modem interface controls, and a sleep mode are some of these features. MCR[5] provides an efficient hardware auto-flow control.

6.1 Internal registers

The SC16C550 provides 15 internal registers for monitoring and control. These registers are shown in Table 3. Twelve registers are similar to those already available in the standard 16C550. These registers function as data holding registers (THR/RHR), interrupt status and control registers (IER/ISR), a FIFO control register (FCR), line status and control registers (LCR/LSR), modem status and control registers (MCR/MSR), programmable data rate (clock) control registers (DLL/DLM), and a user accessible scratchpad register (SPR). Beyond the general 16C550 features and capabilities, the SC16C550 offers an enhanced feature register set (EFR, Xon/Xoff1-2) that provides on-board hardware/software flow control. Register functions are more fully described in the following paragraphs.

Table 3: Internal registers decoding

A2	A1	A0	READ mode	WRITE mode
General register set (THR/RHR, IER/ISR, MCR/MSR, FCR/LSR, SPR)^[1]				
0	0	0	Receive Holding Register	Transmit Holding Register
0	0	1		Interrupt Enable Register
0	1	0	Interrupt Status Register	FIFO Control Register
0	1	1		Line Control Register
1	0	0		Modem Control Register
1	0	1	Line Status Register	n/a
1	1	0	Modem Status Register	n/a
1	1	1	Scratchpad Register	Scratchpad Register
Baud rate register set (DLL/DLM)^[2]				
0	0	0	LSB of Divisor Latch	LSB of Divisor Latch
0	0	1	MSB of Divisor Latch	MSB of Divisor Latch
Enhanced register set (EFR, Xon/off 1-2)^[3]				
0	1	0	Enhanced Feature Register	Enhanced Feature Register
1	0	0	Xon1 word	Xon1 word
1	0	1	Xon2 word	Xon2 word
1	1	0	Xoff1 word	Xoff1 word
1	1	1	Xoff2 word	Xoff2 word

[1] These registers are accessible only when LCR[7] is a logic 0.

[2] These registers are accessible only when LCR[7] is a logic 1.

[3] Enhanced Feature Register, Xon1, 2 and Xoff1, 2 are accessible only when the LCR is set to "BF(HEX).

6.2 FIFO operation

The 16-byte transmit and receive data FIFOs are enabled by the FIFO Control Register bit-0 (FCR[0]). With 16C550 devices, the user can set the receive trigger level, but not the transmit trigger level. The receiver FIFO section includes a time-out function to ensure data is delivered to the external CPU. An interrupt is generated whenever the Receive Holding Register (RHR) has not been read following the loading of a character or the receive trigger level has not been reached.

Table 4: Flow control mechanism

Selected trigger level (characters)	INT pin activation	Negate RTS or send Xoff	Assert RTS or send Xon
1	1	4	1
4	4	8	4
8	8	12	8
14	14	14	10

6.3 Autoflow control (see Figure 5)

Autoflow control is comprised of auto- $\overline{\text{CTS}}$ and auto- $\overline{\text{RTS}}$. With auto- $\overline{\text{CTS}}$, the $\overline{\text{CTS}}$ input must be active before the transmitter FIFO can emit data. With auto- $\overline{\text{RTS}}$, $\overline{\text{RTS}}$ becomes active when the receiver needs more data and notifies the sending serial device. When $\overline{\text{RTS}}$ is connected to $\overline{\text{CTS}}$, data transmission does not occur unless the receiver FIFO has space for the data; thus, overrun errors are eliminated using UART 1 and UART 2 from a SC16C550 with the autoflow control enabled. If not, overrun errors occur when the transmit data rate exceeds the receiver FIFO read latency.

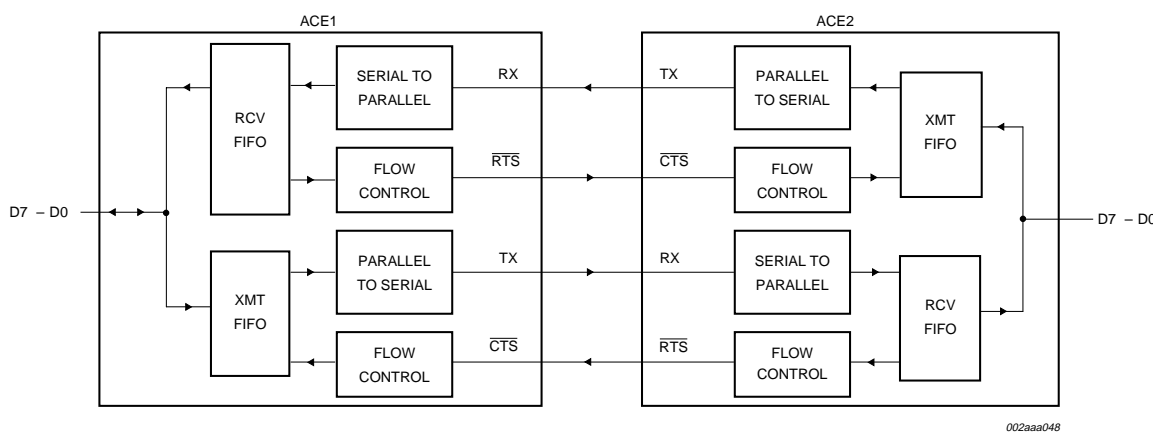

Fig 5. Autoflow control (auto- $\overline{\text{RTS}}$ and auto- $\overline{\text{CTS}}$) example.

6.3.1 Auto- $\overline{\text{RTS}}$ (see Figure 5)

Auto- $\overline{\text{RTS}}$ data flow control originates in the receiver timing and control block (see Figure 1 “Block diagram.”) and is linked to the programmed receiver FIFO trigger level. When the receiver FIFO level reaches a trigger level of 1, 4, or 8 (see Figure 7), $\overline{\text{RTS}}$ is de-asserted. With trigger levels of 1, 4, and 8, the sending UART may send an additional byte after the trigger level is reached (assuming the sending UART has another byte to send) because it may not recognize the de-assertion of $\overline{\text{RTS}}$ until after it has begun sending the additional byte. $\overline{\text{RTS}}$ is automatically reasserted once the RX FIFO is emptied by reading the receiver buffer register. When the trigger level is 14 (see Figure 8), $\overline{\text{RTS}}$ is de-asserted after the first data bit of the 16th character is present on the RX line. $\overline{\text{RTS}}$ is reasserted when the RX FIFO has at least one available byte space.

6.3.2 Auto- $\overline{\text{CTS}}$ (see Figure 5)

The transmitter circuitry checks $\overline{\text{CTS}}$ before sending the next data byte. When $\overline{\text{CTS}}$ is active, it sends the next byte. To stop the transmitter from sending the following byte, $\overline{\text{CTS}}$ must be released before the middle of the last stop bit that is currently being sent (see Figure 6). The auto- $\overline{\text{CTS}}$ function reduces interrupts to the host system. When flow control is enabled, $\overline{\text{CTS}}$ level changes do not trigger host interrupts because the device automatically controls its own transmitter. Without auto- $\overline{\text{CTS}}$, the transmitter sends any data present in the transmit FIFO and a receiver overrun error may result.

6.3.3 Enabling autoflow control and auto- $\overline{\text{CTS}}$

Autoflow control is enabled by setting Enhanced Feature register bits 6 and 7 (autoflow enable or AFE) to a '1'.

6.3.4 Auto- $\overline{\text{CTS}}$ and auto- $\overline{\text{RTS}}$ functional timing

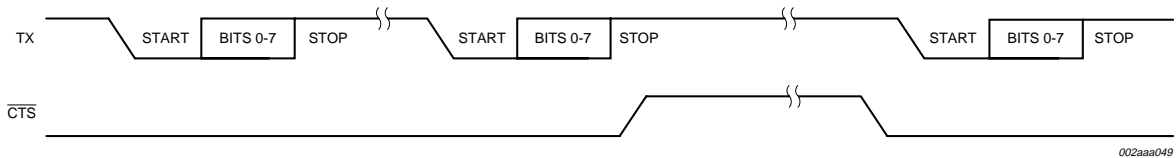

- (1) When $\overline{\text{CTS}}$ is LOW, the transmitter keeps sending serial data out.
- (2) If $\overline{\text{CTS}}$ goes HIGH before the middle of the last stop bit of the current byte, the transmitter finishes sending the current byte, but it does not send the next byte.
- (3) When $\overline{\text{CTS}}$ goes from HIGH to LOW, the transmitter begins sending data again.

Fig 6. $\overline{\text{CTS}}$ functional timing waveforms.

The receiver FIFO trigger level can be set to 1, 4, 8, or 14 bytes. These are described in Figure 7 and Figure 8.

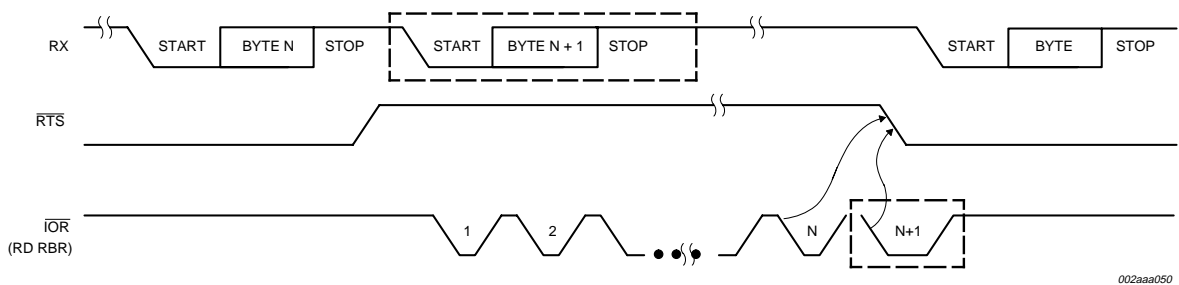

- (1) N = RCV FIFO trigger level (1, 4, or 8 bytes).
- (2) The two blocks in dashed lines cover the case where an additional byte is sent as described in the preceding auto- $\overline{\text{RTS}}$ section.

Fig 7. $\overline{\text{RTS}}$ functional timing waveforms, RCV FIFO trigger level = 1, 4, or 8 bytes.

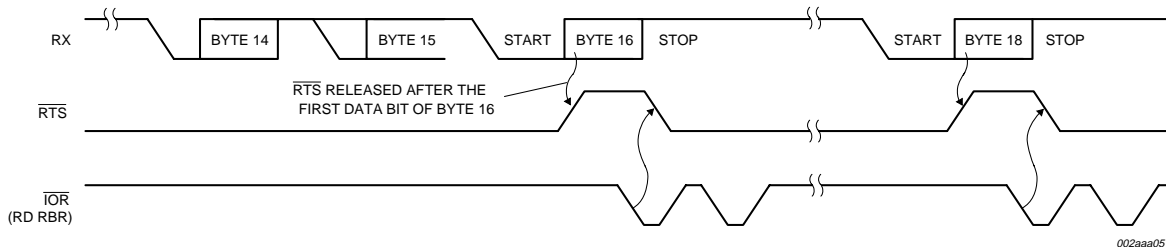

- (1) $\overline{\text{RTS}}$ is de-asserted when the receiver receives the first data bit of the sixteenth byte. The receive FIFO is full after finishing the sixteenth byte.
- (2) $\overline{\text{RTS}}$ is asserted again when there is at least one byte of space available and no incoming byte is in processing, or there is more than one byte of space available.
- (3) When the receive FIFO is full, the first receive buffer register read re-asserts $\overline{\text{RTS}}$.

Fig 8. $\overline{\text{RTS}}$ functional timing waveforms, RCV FIFO trigger level = 14 bytes.

6.4 Software flow control

When software flow control is enabled, the SC16C550 compares one or two sequential receive data characters with the programmed Xon or Xoff character value(s). If receive character(s) (RX) match the programmed values, the SC16C550 will halt transmission (TX) as soon as the current character(s) has completed transmission. When a match occurs, the receive ready (if enabled via Xoff IER[5]) flags will be set and the interrupt output pin (if receive interrupt is enabled) will be activated. Following a suspension due to a match of the Xoff characters' values, the SC16C550 will monitor the receive data stream for a match to the Xon_{1,2} character value(s). If a match is found, the SC16C550 will resume operation and clear the flags (ISR[4]).

Reset initially sets the contents of the Xon/Xoff 8-bit flow control registers to a logic 0. Following reset, the user can write any Xon/Xoff value desired for software flow control. Different conditions can be set to detect Xon/Xoff characters and suspend/resume transmissions. When double 8-bit Xon/Xoff characters are selected, the SC16C550 compares two consecutive receive characters with two software flow control 8-bit values (Xon₁, Xon₂, Xoff₁, Xoff₂) and controls TX transmissions accordingly. Under the above described flow control mechanisms, flow control characters are not placed (stacked) in the user accessible RX data buffer or FIFO. When using a software flow control the Xon/Xoff characters cannot be used for data transfer.

In the event that the receive buffer is overfilling and flow control needs to be executed, the SC16C550 automatically sends an Xoff message (when enabled) via the serial TX output to the remote modem. The SC16C550 sends the Xoff_{1,2} characters as soon as received data passes the programmed trigger level. To clear this condition, the SC16C550 will transmit the programmed Xon_{1,2} characters as soon as receive data drops below the programmed trigger level.

6.5 Special feature software flow control

A special feature is provided to detect an 8-bit character when EFR[5] is set. When 8-bit character is detected, it will be placed on the user-accessible data stack along with normal incoming RX data. This condition is selected in conjunction with EFR[0-3]. Note that software flow control should be turned off when using this special mode by setting EFR[0-3] to a logic 0.

The SC16C550 compares each incoming receive character with Xoff2 data. If a match exists, the received data will be transferred to the FIFO, and ISR[4] will be set to indicate detection of a special character. Although [Table 8 "SC16C550 internal registers"](#) shows each X-Register with eight bits of character information, the actual number of bits is dependent on the programmed word length. Line Control Register bits LCR[0-1] define the number of character bits, i.e., either 5 bits, 6 bits, 7 bits or 8 bits. The word length selected by LCR[0-1] also determine the number of bits that will be used for the special character comparison. Bit 0 in the X-registers corresponds with the LSB bit for the receive character.

6.6 Hardware/software and time-out interrupts

Three special interrupts have been added to monitor the hardware and software flow control. The interrupts are enabled by IER[5-7]. Care must be taken when handling these interrupts. Following a reset, the transmitter interrupt is enabled, the SC16C550 will issue an interrupt to indicate that the Transmit Holding Register is empty. This interrupt must be serviced prior to continuing operations. The LSR register provides the current singular highest priority interrupt only. It could be noted that CTS and RTS interrupts have lowest interrupt priority. A condition can exist where a higher priority interrupt may mask the lower priority CTS/RTS interrupt(s). Only after servicing the higher pending interrupt will the lower priority CTS/TRS interrupt(s) be reflected in the status register. Servicing the interrupt without investigating further interrupt conditions can result in data errors.

When two interrupt conditions have the same priority, it is important to service these interrupts correctly. Receive Data Ready and Receive Time Out have the same interrupt priority (when enabled by IER[3]). The receiver issues an interrupt after the number of characters have reached the programmed trigger level. In this case, the SC16C550 FIFO may hold more characters than the programmed trigger level. Following the removal of a data byte, the user should re-check LSR[0] for additional characters. A Receive Time Out will not occur if the receive FIFO is empty. The time-out counter is reset at the center of each stop bit received or each time the receive holding register (RHR) is read. The actual time-out value is 4 character time, including data information length, start bit, parity bit, and the size of stop bit, i.e., 1×, 1.5×, or 2× bit times.

6.7 Programmable baud rate generator

The SC16C550 supports high speed modem technologies that have increased input data rates by employing data compression schemes. For example, a 33.6 kbit/s modem that employs data compression may require a 115.2 kbit/s input data rate. A 128.0 kbit/s ISDN modem that supports data compression may need an input data rate of 460.8 kbit/s. The SC16C550 can support a standard data rate of 921.6 kbit/s.

A single baud rate generator is provided for the transmitter and receiver, allowing independent TX/RX channel control. The programmable Baud Rate Generator is capable of accepting an input clock up to 48 MHz, as required for supporting a 3 Mbits/s data rate. The SC16C550 can be configured for internal or external clock operation. For internal clock oscillator operation, an industry standard microprocessor crystal is connected externally between the XTAL1 and XTAL2 pins (see [Figure 9](#)). Alternatively, an external clock can be connected to the XTAL1 pin to clock the internal baud rate generator for standard or custom rates (see [Table 5](#)).

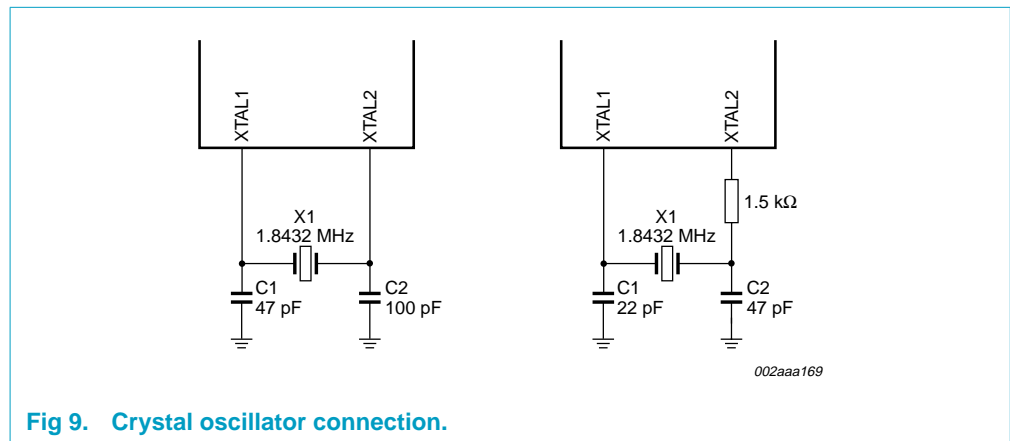

Fig 9. Crystal oscillator connection.

The generator divides the input $16\times$ clock by any divisor from 1 to $2^{16} - 1$. The SC16C550 divides the basic crystal or external clock by 16. The frequency of the $\overline{\text{BAUDOUT}}$ output pin is exactly $16\times$ (16 times) of the selected baud rate ($\overline{\text{BAUDOUT}} = 16 \text{ Baud Rate}$). Customized baud rates can be achieved by selecting the proper divisor values for the MSB and LSB sections of baud rate generator.

Programming the Baud Rate Generator registers DLM (MSB) and DLL (LSB) provides a user capability for selecting the desired final baud rate. The example in [Table 5](#) shows selectable baud rates when using a 1.8432 MHz crystal.

For custom baud rates, the divisor value can be calculated using the following equation:

$$\text{Divisor (in decimal)} = \frac{\text{XTAL1 clock frequency}}{\text{serial data rate} \times 16} \quad (1)$$

Table 5: Baud rates using 1.8432 MHz or 3.072 MHz crystal

Using 1.8432 MHz crystal			Using 3.072 MHz crystal		
Desired baud rate	Divisor for 16× clock	Baud rate error	Desired baud rate	Divisor for 16× clock	Baud rate error
50	2304		50	3840	
75	1536		75	2560	
110	1047	0.026	110	1745	0.026
134.5	857	0.058	134.5	1428	0.034
150	768		150	1280	
300	384		300	640	
600	192		600	320	
1200	96		1200	160	
1800	64		1800	107	0.312
2000	58	0.69	2000	96	
2400	48		2400	80	
3600	32		3600	53	0.628
4800	24		4800	40	
7200	16		7200	27	1.23
9600	12		9600	20	
19200	6		19200	10	
38400	3		38400	5	
56000	2	2.86			

6.8 DMA operation

The SC16C550 FIFO trigger level provides additional flexibility to the user for block mode operation. The user can optionally operate the transmit and receive FIFOs in the DMA mode (FCR[3]). The DMA mode affects the state of the $\overline{\text{RXRDY}}$ and $\overline{\text{TXRDY}}$ output pins. Tables 6 and 7 show this.

Table 6: Effect of DMA mode on state of $\overline{\text{RXRDY}}$ pin

Non-DMA mode	DMA mode
1 = FIFO empty	0-to-1 transition when FIFO empties
0 = at least 1 byte in FIFO	1-to-0 transition when FIFO reaches trigger level, or time-out occurs

Table 7: Effect of DMA mode on state of $\overline{\text{TXRDY}}$ pin

Non-DMA mode	DMA mode
1 = at least 1 byte in FIFO	1 = FIFO is full
0 = FIFO empty	0 = FIFO has at least 1 empty location

6.9 Sleep mode

The SC16C550 is designed to operate with low power consumption. A special sleep mode is included to further reduce power consumption when the chip is not being used. With EFR[4] and IER[4] enabled (set to a logic 1), the SC16C550 enters the sleep mode, but resumes normal operation when a start bit is detected, a change of state on any of the modem input pins \overline{RX} , \overline{RI} , \overline{CTS} , \overline{DSR} , \overline{DCD} , or a transmit data is provided by the user. If the sleep mode is enabled and the SC16C550 is awakened by one of the conditions described above, it will return to the sleep mode automatically after the last character is transmitted or read by the user. In any case, the sleep mode will not be entered while an interrupt(s) is pending. The SC16C550 will stay in the sleep mode of operation until it is disabled by setting IER[4] to a logic 0.

6.10 Loop-back mode

The internal loop-back capability allows on-board diagnostics. In the loop-back mode, the normal modem interface pins are disconnected and reconfigured for loop-back internally. MCR[0-3] register bits are used for controlling loop-back diagnostic testing. In the loop-back mode, OUT1 and OUT2 in the MCR register (bits 3-2) control the modem \overline{RI} and \overline{DCD} inputs, respectively. MCR signals \overline{DTR} and \overline{RTS} (bits 0-1) are used to control the modem \overline{CTS} and \overline{DSR} inputs, respectively. The transmitter output (TX) and the receiver input (RX) are disconnected from their associated interface pins, and instead are connected together internally (see Figure 10). The \overline{CTS} , \overline{DSR} , \overline{DCD} , and \overline{RI} are disconnected from their normal modem control input pins, and instead are connected internally to \overline{DTR} , \overline{RTS} , OUT1 and OUT2. Loop-back test data is entered into the transmit holding register via the user data bus interface, D0-D7. The transmit UART serializes the data and passes the serial data to the receive UART via the internal loop-back connection. The receive UART converts the serial data back into parallel data that is then made available at the user data interface D0-D7. The user optionally compares the received data to the initial transmitted data for verifying error-free operation of the UART TX/RX circuits.

In this mode, the receiver and transmitter interrupts are fully operational. The Modem Control Interrupts are also operational. However, the interrupts can only be read using lower four bits of the Modem Status Register (MSR[0-3]) instead of the four Modem Status Register bits 4-7. The interrupts are still controlled by the IER.

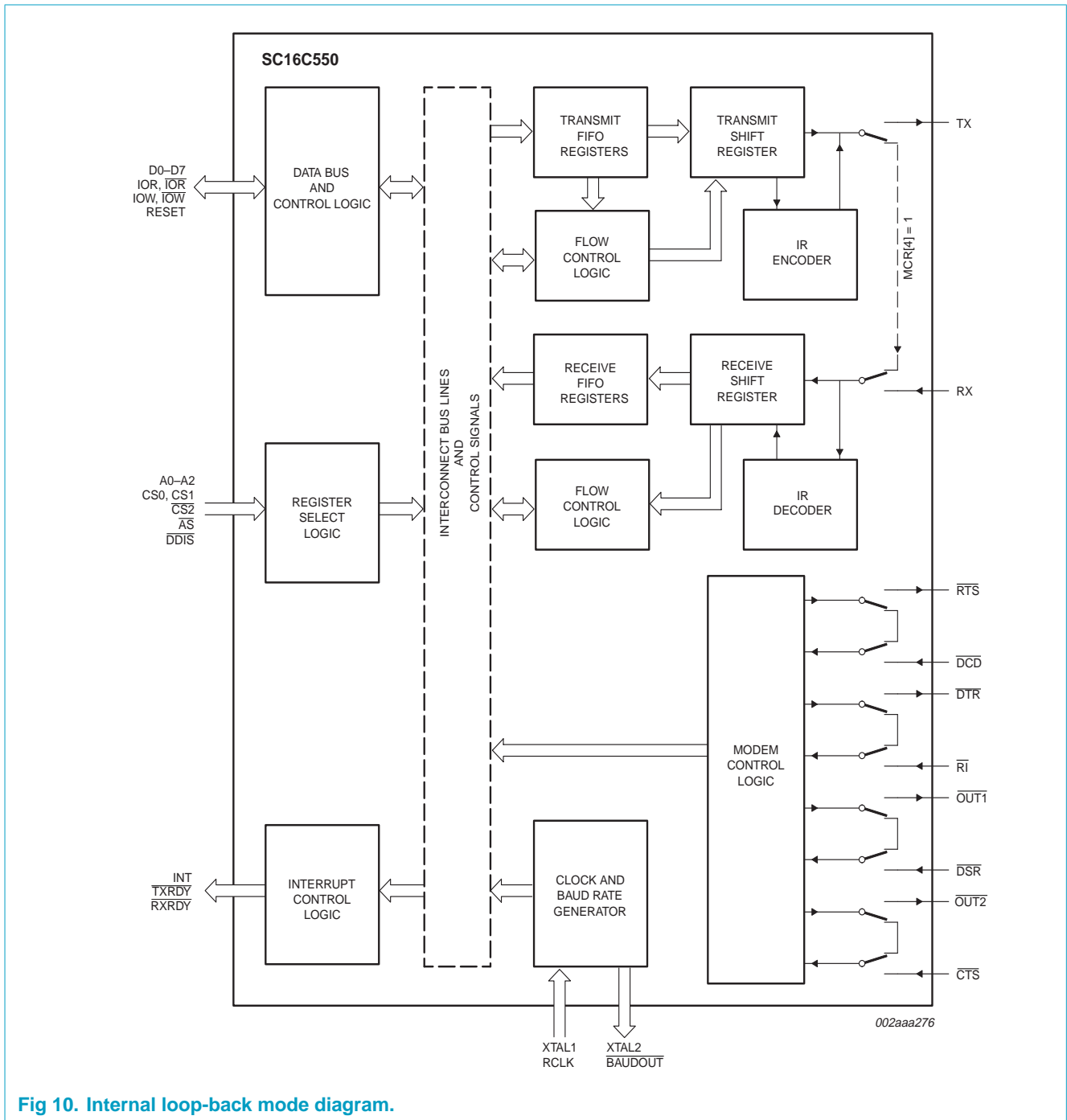

Fig 10. Internal loop-back mode diagram.

7. Register descriptions

Table 8 details the assigned bit functions for the fifteen SC16C550 internal registers. The assigned bit functions are more fully defined in [Section 7.1](#) through [Section 7.11](#).

Table 8: SC16C550 internal registers

Shaded bits are only accessible when EFR[4] is set.

A2	A1	A0	Register	Default ^[1]	Bit 7	Bit 6	Bit 5	Bit 4	Bit 3	Bit 2	Bit 1	Bit 0
General Register Set^[2]												
0	0	0	RHR	XX	bit 7	bit 6	bit 5	bit 4	bit 3	bit 2	bit 1	bit 0
0	0	0	THR	XX	bit 7	bit 6	bit 5	bit 4	bit 3	bit 2	bit 1	bit 0
0	0	1	IER	00	CTS interrupt	RTS interrupt	Xoff interrupt	Sleep mode	modem status interrupt	receive line status interrupt	transmit holding register	receive holding register
0	1	0	FCR	00	RCVR trigger (MSB)	RCVR trigger (LSB)	reserved	reserved	DMA mode select	XMIT FIFO reset	RCVR FIFO reset	FIFO enable
0	1	0	ISR	01	FIFOs enabled	FIFOs enabled	INT priority bit 4	INT priority bit 3	INT priority bit 2	INT priority bit 1	INT priority bit 0	INT status
0	1	1	LCR	00	divisor latch enable	set break	set parity	even parity	parity enable	stop bits	word length bit 1	word length bit 0
1	0	0	MCR	00	reserved	IR enable	reserved	loop back	OUT2, INT enable	OUT1	RTS	DTR
1	0	1	LSR	60	FIFO data error	trans. empty	trans. holding empty	break interrupt	framing error	parity error	overrun error	receive data ready
1	1	0	MSR	X0	DCD	RI	DSR	CTS	Δ DCD	Δ RI	Δ DSR	Δ CTS
1	1	1	SPR	FF	bit 7	bit 6	bit 5	bit 4	bit 3	bit 2	bit 1	bit 0
Special Register Set^[3]												
0	0	0	DLL	XX	bit 7	bit 6	bit 5	bit 4	bit 3	bit 2	bit 1	bit 0
0	0	1	DLM	XX	bit 15	bit 14	bit 13	bit 12	bit 11	bit 10	bit 9	bit 8
Enhanced Register Set^[4]												
0	1	0	EFR	00	Auto CTS	Auto RTS	Special char. select	Enable IER[4-7], ISR[4,5], FCR[4,5], MCR[5-7]	Cont-3 Tx, Rx Control	Cont-2 Tx, Rx Control	Cont-1 Tx, Rx Control	Cont-0 Tx, Rx Control
1	0	0	Xon-1	00	bit 7	bit 6	bit 5	bit 4	bit 3	bit 2	bit 1	bit 0
1	0	1	Xon-2	00	bit 15	bit 14	bit 13	bit 12	bit 11	bit 10	bit 9	bit 8
1	1	0	Xoff-1	00	bit 7	bit 6	bit 5	bit 4	bit 3	bit 2	bit 1	bit 0
1	1	1	Xoff-2	00	bit 15	bit 14	bit 13	bit 12	bit 11	bit 10	bit 9	bit 8

[1] The value shown represents the register's initialized HEX value; X = n/a.

[2] These registers are accessible only when LCR[7] = 0.

[3] The Special Register set is accessible only when LCR[7] is set to a logic 1.

[4] Enhanced Feature Register, Xon-1,2 and Xoff-1,2 are accessible only when LCR is set to 'BF_{Hex}'.

7.1 Transmit (THR) and Receive (RHR) Holding Registers

The serial transmitter section consists of an 8-bit Transmit Hold Register (THR) and Transmit Shift Register (TSR). The status of the THR is provided in the Line Status Register (LSR). Writing to the THR transfers the contents of the data bus (D7-D0) to the THR, providing that the THR or TSR is empty. The THR empty flag in the LSR register will be set to a logic 1 when the transmitter is empty or when data is transferred to the TSR. Note that a write operation can be performed when the THR empty flag is set (logic 0 = FIFO full; logic 1 = at least one FIFO location available).

The serial receive section also contains an 8-bit Receive Holding Register (RHR). Receive data is removed from the SC16C550 and receive FIFO by reading the RHR register. The receive section provides a mechanism to prevent false starts. On the falling edge of a start or false start bit, an internal receiver counter starts counting clocks at the $16\times$ clock rate. After $7\frac{1}{2}$ clocks, the start bit time should be shifted to the center of the start bit. At this time the start bit is sampled, and if it is still a logic 0 it is validated. Evaluating the start bit in this manner prevents the receiver from assembling a false character. Receiver status codes will be posted in the LSR.

7.2 Interrupt Enable Register (IER)

The Interrupt Enable Register (IER) masks the interrupts from receiver ready, transmitter empty, line status and modem status registers. These interrupts would normally be seen on the INT output pin.

Table 9: Interrupt Enable Register bits description

Bit	Symbol	Description
7	IER[7]	CTS interrupt. Logic 0 = Disable the CTS interrupt (normal default condition). Logic 1 = Enable the CTS interrupt. The SC16C550 issues an interrupt when the $\overline{\text{CTS}}$ pin transitions from a logic 0 to a logic 1.
6	IER[6]	RTS interrupt. Logic 0 = Disable the RTS interrupt (normal default condition). Logic 1 = Enable the RTS interrupt. The SC16C550 issues an interrupt when the $\overline{\text{RTS}}$ pin transitions from a logic 0 to a logic 1.
5	IER[5]	Xoff interrupt. Logic 0 = Disable the software flow control, receive Xoff interrupt (normal default condition). Logic 1 = Enable the software flow control, receive Xoff interrupt. See Section 6.4 "Software flow control" for details.
4	IER[4]	Sleep mode. Logic 0 = Disable sleep mode (normal default condition). Logic 1 = Enable sleep mode. See Section 6.9 "Sleep mode" for details.
3	IER[3]	Modem Status Interrupt. Logic 0 = Disable the modem status register interrupt (normal default condition). Logic 1 = Enable the modem status register interrupt.

Table 9: Interrupt Enable Register bits description...continued

Bit	Symbol	Description
2	IER[2]	Receive Line Status interrupt. This interrupt will be issued whenever a fully assembled receive character is transferred from RSR to the RHR/FIFO, i.e., data ready, LSR[0]. Logic 0 = Disable the receiver line status interrupt (normal default condition). Logic 1 = Enable the receiver line status interrupt.
1	IER[1]	Transmit Holding Register interrupt. This interrupt will be issued whenever the THR is empty, and is associated with LSR[1]. Logic 0 = Disable the transmitter empty interrupt (normal default condition). Logic 1 = Enable the transmitter empty interrupt.
0	IER[0]	Receive Holding Register interrupt. This interrupt will be issued when the FIFO has reached the programmed trigger level, or is cleared when the FIFO drops below the trigger level in the FIFO mode of operation. Logic 0 = Disable the receiver ready interrupt (normal default condition). Logic 1 = Enable the receiver ready interrupt.

7.2.1 IER versus Receive FIFO interrupt mode operation

When the receive FIFO (FCR[0] = logic 1), and receive interrupts (IER[0] = logic 1) are enabled, the receive interrupts and register status will reflect the following:

- The receive data available interrupts are issued to the external CPU when the FIFO has reached the programmed trigger level. It will be cleared when the FIFO drops below the programmed trigger level.
- FIFO status will also be reflected in the user accessible ISR register when the FIFO trigger level is reached. Both the ISR register status bit and the interrupt will be cleared when the FIFO drops below the trigger level.
- The data ready bit (LSR[0]) is set as soon as a character is transferred from the shift register to the receive FIFO. It is reset when the FIFO is empty.

7.2.2 IER versus Receive/Transmit FIFO polled mode operation

When FCR[0] = logic 1, resetting IER[0-3] enables the SC16C550 in the FIFO polled mode of operation. Since the receiver and transmitter have separate bits in the LSR, either or both can be used in the polled mode by selecting respective transmit or receive control bit(s).

- LSR[0] will be a logic 1 as long as there is one byte in the receive FIFO.
- LSR[1-4] will provide the type of errors encountered, if any.
- LSR[5] will indicate when the transmit FIFO is empty.
- LSR[6] will indicate when both the transmit FIFO and transmit shift register are empty.
- LSR[7] will indicate any FIFO data errors.

7.3 FIFO Control Register (FCR)

This register is used to enable the FIFOs, clear the FIFOs, set the receive FIFO trigger levels, and select the DMA mode.

7.3.1 DMA mode

Mode 0 (FCR bit 3 = '0'): Set and enable the interrupt for each single transmit or receive operation, and is similar to the 16C450 mode. Transmit Ready ($\overline{\text{TXRDY}}$) will go to a logic 0 whenever an empty transmit space is available in the Transmit Holding Register (THR). Receive Ready ($\overline{\text{RXRDY}}$) will go to a logic 0 whenever the Receive Holding Register (RHR) is loaded with a character.

Mode 1 (FCR bit 3 = '1'): Set and enable the interrupt in a block mode operation. The transmit interrupt is set when the transmit FIFO has at least one empty location. The receive interrupt is set when the receive FIFO fills to the programmed trigger level. However, the FIFO continues to fill regardless of the programmed level until the FIFO is full. $\overline{\text{RXRDY}}$ remains a logic 0 as long as the FIFO fill level is above the programmed trigger level.

7.3.2 FIFO mode

Table 10: FIFO Control Register bits description

Bit	Symbol	Description
7-6	FCR[7] (MSB), FCR[6] (LSB)	RCVR trigger. These bits are used to set the trigger level for the receive FIFO interrupt. An interrupt is generated when the number of characters in the FIFO equals the programmed trigger level. However, the FIFO will continue to be loaded until it is full. Refer to Table 11 .
5-4	FCR[5] (MSB), FCR[4] (LSB)	Not used; set to 00.
3	FCR[3]	DMA mode select. Logic 0 = Set DMA mode '0' (normal default condition). Logic 1 = Set DMA mode '1'

Transmit operation in mode '0': When the SC16C550 is in the 16C450 mode (FIFOs disabled; FCR[0] = logic 0) or in the FIFO mode (FIFOs enabled; FCR[0] = logic 1; FCR[3] = logic 0), and when there are no characters in the transmit FIFO or transmit holding register, the $\overline{\text{TXRDY}}$ pin will be a logic 0. Once active, the $\overline{\text{TXRDY}}$ pin will go to a logic 1 after the first character is loaded into the transmit holding register.

Receive operation in mode '0': When the SC16C550 is in 16C450 mode, or in the FIFO mode (FCR[0] = logic 1; FCR[3] = logic 0) and there is at least one character in the receive FIFO, the $\overline{\text{RXRDY}}$ pin will be a logic 0. Once active, the $\overline{\text{RXRDY}}$ pin will go to a logic 1 when there are no more characters in the receiver.

Table 10: FIFO Control Register bits description...continued

Bit	Symbol	Description
		<p>Transmit operation in mode '1': When the SC16C550 is in FIFO mode (FCR[0] = logic 1; FCR[3] = logic 1), the $\overline{\text{TXRDY}}$ pin will be a logic 1 when the transmit FIFO is completely full. It will be a logic 0 if one or more FIFO locations are empty.</p> <p>Receive operation in mode '1': When the SC16C550 is in FIFO mode (FCR[0] = logic 1; FCR[3] = logic 1) and the trigger level has been reached, or a Receive Time-Out has occurred, the $\overline{\text{RXRDY}}$ pin will go to a logic 0. Once activated, it will go to a logic 1 after there are no more characters in the FIFO.</p>
2	FCR[2]	<p>XMIT FIFO reset.</p> <p>Logic 0 = No FIFO transmit reset (normal default condition).</p> <p>Logic 1 = Clears the contents of the transmit FIFO and resets the FIFO counter logic (the transmit shift register is not cleared or altered). This bit will return to a logic 0 after clearing the FIFO.</p>
1	FCR[1]	<p>RCVR FIFO reset.</p> <p>Logic 0 = No FIFO receive reset (normal default condition).</p> <p>Logic 1 = Clears the contents of the receive FIFO and resets the FIFO counter logic (the receive shift register is not cleared or altered). This bit will return to a logic 0 after clearing the FIFO.</p>
0	FCR[0]	<p>FIFO enable.</p> <p>Logic 0 = Disable the transmit and receive FIFO (normal default condition).</p> <p>Logic 1 = Enable the transmit and receive FIFO. This bit must be a '1' when other FCR bits are written to, or they will not be programmed.</p>

Table 11: RCVR trigger levels

FCR[7]	FCR[6]	RX FIFO trigger level (bytes)
0	0	1
0	1	4
1	0	8
1	1	14

7.4 Interrupt Status Register (ISR)

The SC16C550 provides six levels of prioritized interrupts to minimize external software interaction. The Interrupt Status Register (ISR) provides the user with six interrupt status bits. Performing a read cycle on the ISR will provide the user with the highest pending interrupt level to be serviced. No other interrupts are acknowledged until the pending interrupt is serviced. Whenever the interrupt status register is read, the interrupt status is cleared. However, it should be noted that only the current pending interrupt is cleared by the read. A lower level interrupt may be seen after re-reading the interrupt status bits. [Table 12 “Interrupt source”](#) shows the data values (bits 0-5) for the six prioritized interrupt levels and the interrupt sources associated with each of these interrupt levels.

Table 12: Interrupt source

Priority level	ISR[5]	ISR[4]	ISR[3]	ISR[2]	ISR[1]	ISR[0]	Source of the interrupt
1	0	0	0	1	1	0	LSR (Receiver Line Status Register)
2	0	0	0	1	0	0	RXRDY (Received Data Ready)
2	0	0	1	1	0	0	RXRDY (Receive Data time-out)
3	0	0	0	0	1	0	TXRDY (Transmitter Holding Register Empty)
4	0	0	0	0	0	0	MSR (Modem Status Register)
5	0	1	0	0	0	0	RXRDY (Received Xoff signal) / Special character
6	1	0	0	0	0	0	CTS, RTS change of state

Table 13: Interrupt Status Register bits description

Bit	Symbol	Description
7-6	ISR[7-6]	FIFOs enabled. These bits are set to a logic 0 when the FIFO is not being used. They are set to a logic 1 when the FIFOs are enabled. Logic 0 or cleared = default condition.
5-4	ISR[5-4]	INT priority bits 4-3. These bits are enabled when EFR[4] is set to a logic 1. ISR[4] indicates that matching Xoff character(s) have been detected. ISR[5] indicates that CTS, RTS have been generated. Note that once set to a logic 1, the ISR[4] bit will stay a logic 1 until Xon character(s) are received. Logic 0 or cleared = default condition.
3-1	ISR[3-1]	INT priority bits 2-0. These bits indicate the source for a pending interrupt at interrupt priority levels 1, 2, and 3 (see Table 12). Logic 0 or cleared = default condition.
0	ISR[0]	INT status. Logic 0 = An interrupt is pending and the ISR contents may be used as a pointer to the appropriate interrupt service routine. Logic 1 = No interrupt pending (normal default condition).

7.5 Line Control Register (LCR)

The Line Control Register is used to specify the asynchronous data communication format. The word length, the number of stop bits, and the parity are selected by writing the appropriate bits in this register.

Table 14: Line Control Register bits description

Bit	Symbol	Description
7	LCR[7] ^[1]	<p>Divisor latch enable. The internal baud rate counter latch and Enhance Feature mode enable.</p> <p>Logic 0 = Divisor latch disabled (normal default condition).</p> <p>Logic 1 = Divisor latch and enhanced feature register enabled.</p>
6	LCR[6]	<p>Set break. When enabled, the Break control bit causes a break condition to be transmitted (the TX output is forced to a logic 0 state). This condition exists until disabled by setting LCR[6] to a logic 0.</p> <p>Logic 0 = no TX break condition (normal default condition).</p> <p>Logic 1 = forces the transmitter output (TX) to a logic 0 for alerting the remote receiver to a line break condition.</p>
5	LCR[5]	<p>Set parity. If the parity bit is enabled, LCR[5] selects the forced parity format. Programs the parity conditions (see Table 15).</p> <p>Logic 0 = parity is not forced (normal default condition).</p> <p>LCR[5] = logic 1 and LCR[4] = logic 0: parity bit is forced to a logical 1 for the transmit and receive data.</p> <p>LCR[5] = logic 1 and LCR[4] = logic 1: parity bit is forced to a logical 0 for the transmit and receive data.</p>
4	LCR[4]	<p>Even parity. If the parity bit is enabled with LCR[3] set to a logic 1, LCR[4] selects the even or odd parity format.</p> <p>Logic 0 = ODD Parity is generated by forcing an odd number of logic 1s in the transmitted data. The receiver must be programmed to check the same format (normal default condition).</p> <p>Logic 1 = EVEN Parity is generated by forcing an even number of logic 1s in the transmitted data. The receiver must be programmed to check the same format.</p>
3	LCR[3]	<p>Parity enable. Parity or no parity can be selected via this bit.</p> <p>Logic 0 = no parity (normal default condition).</p> <p>Logic 1 = a parity bit is generated during the transmission, receiver checks the data and parity for transmission errors.</p>
2	LCR[2]	<p>Stop bits. The length of stop bit is specified by this bit in conjunction with the programmed word length (see Table 16).</p> <p>Logic 0 or cleared = default condition.</p>
1-0	LCR[1-0]	<p>Word length bits 1, 0. These two bits specify the word length to be transmitted or received (see Table 17).</p> <p>Logic 0 or cleared = default condition.</p>

[1] When LCR[7] = 1, the general register set cannot be accessed until LCR[7] = 0.

Table 15: LCR[5] parity selection

LCR[5]	LCR[4]	LCR[3]	Parity selection
X	X	0	no parity
0	0	1	ODD parity
0	1	1	EVEN parity
1	0	1	force parity '1'
1	1	1	forced parity '0'

Table 16: LCR[2] stop bit length

LCR[2]	Word length	Stop bit length (bit times)
0	5, 6, 7, 8	1
1	5	1-1/2
1	6, 7, 8	2

Table 17: LCR[1-0] word length

LCR[1]	LCR[0]	Word length
0	0	5
0	1	6
1	0	7
1	1	8

7.6 Modem Control Register (MCR)

This register controls the interface with the modem or a peripheral device.

Table 18: Modem Control Register bits description

Bit	Symbol	Description
7	MCR[7]	Reserved; set to '0'.
6	MCR[6]	IR enable. Logic 0 = Enable the standard modem receive and transmit input/output interface (normal default condition). Logic 1 = Enable infrared IrDA receive and transmit inputs/outputs. While in this mode, the TX/RX output/inputs are routed to the infrared encoder/decoder. The data input and output levels will conform to the IrDA infrared interface requirement. As such, while in this mode, the infrared TX output will be a logic 0 during idle data conditions.
5	MCR[5]	Reserved; set to '0'. Use EFR[6,7] to enable Auto RTS, CTS flow control.
4	MCR[4]	Loop-back. Enable the local loop-back mode (diagnostics). In this mode the transmitter output (\overline{TX}) and the receiver input (\overline{RX}), \overline{CTS} , \overline{DSR} , \overline{DCD} , and \overline{RI} are disconnected from the SC16C550 I/O pins. Internally the modem data and control pins are connected into a loop-back data configuration (see Figure 10). In this mode, the receiver and transmitter interrupts remain fully operational. The Modem Control Interrupts are also operational, but the interrupts' sources are switched to the lower four bits of the Modem Control. Interrupts continue to be controlled by the IER register. Logic 0 = Disable loop-back mode (normal default condition). Logic 1 = Enable local loop-back mode (diagnostics).
3	MCR[3]	$\overline{OUT2}$, INTx enable. Used to control the modem \overline{DCD} signal in the loop-back mode. Logic 0 = Forces INT output to the 3-State mode. In the loop-back mode, sets $\overline{OUT2}$ (\overline{DCD}) internally to a logic 1. Logic 1 = Forces the INT output to the active mode. In the loop-back mode, sets $\overline{OUT2}$ (\overline{DCD}) internally to a logic 0.
2	MCR[2]	$\overline{OUT1}$. This bit is used in the Loop-back mode only. In the loop-back mode, this bit is used to write the state of the modem \overline{RI} interface signal via $\overline{OUT1}$.
1	MCR[1]	\overline{RTS} Logic 0 = Force \overline{RTS} output to a logic 1 (normal default condition). Logic 1 = Force \overline{RTS} output to a logic 0.
0	MCR[0]	\overline{DTR} Logic 0 = Force \overline{DTR} output to a logic 1 (normal default condition). Logic 1 = Force \overline{DTR} output to a logic 0.

7.7 Line Status Register (LSR)

This register provides the status of data transfers between the SC16C550 and the CPU.

Table 19: Line Status Register bits description

Bit	Symbol	Description
7	LSR[7]	FIFO data error. Logic 0 = No error (normal default condition). Logic 1 = At least one parity error, framing error or break indication is in the current FIFO data. This bit is cleared when LSR register is read.
6	LSR[6]	THR and TSR empty. This bit is the Transmit Empty indicator. This bit is set to a logic 1 whenever the transmit holding register and the transmit shift register are both empty. It is reset to logic 0 whenever either the THR or TSR contains a data character. In the FIFO mode, this bit is set to '1' whenever the transmit FIFO and transmit shift register are both empty.
5	LSR[5]	THR empty. This bit is the Transmit Holding Register Empty indicator. This bit indicates that the UART is ready to accept a new character for transmission. In addition, this bit causes the UART to issue an interrupt to CPU when the THR interrupt enable is set. The THR bit is set to a logic 1 when a character is transferred from the transmit holding register into the transmitter shift register. The bit is reset to a logic 0 concurrently with the loading of the transmitter holding register by the CPU. In the FIFO mode, this bit is set when the transmit FIFO is empty; it is cleared when at least 1 byte is written to the transmit FIFO.
4	LSR[4]	Break interrupt. Logic 0 = No break condition (normal default condition). Logic 1 = The receiver received a break signal (RX was a logic 0 for one character frame time). In the FIFO mode, only one break character is loaded into the FIFO.
3	LSR[3]	Framing error. Logic 0 = No framing error (normal default condition). Logic 1 = Framing error. The receive character did not have a valid stop bit(s). In the FIFO mode, this error is associated with the character at the top of the FIFO.
2	LSR[2]	Parity error. Logic 0 = No parity error (normal default condition). Logic 1 = Parity error. The receive character does not have correct parity information and is suspect. In the FIFO mode, this error is associated with the character at the top of the FIFO.
1	LSR[1]	Overrun error. Logic 0 = No overrun error (normal default condition). Logic 1 = Overrun error. A data overrun error occurred in the receive shift register. This happens when additional data arrives while the FIFO is full. In this case, the previous data in the shift register is overwritten. Note that under this condition, the data byte in the receive shift register is not transferred into the FIFO, therefore the data in the FIFO is not corrupted by the error.

Table 19: Line Status Register bits description...continued

Bit	Symbol	Description
0	LSR[0]	Receive data ready. Logic 0 = No data in receive holding register or FIFO (normal default condition). Logic 1 = Data has been received and is saved in the receive holding register or FIFO.

7.8 Modem Status Register (MSR)

This register provides the current state of the control interface signals from the modem, or other peripheral device to which the SC16C550 is connected. Four bits of this register are used to indicate the changed information. These bits are set to a logic 1 whenever a control input from the modem changes state. These bits are set to a logic 0 whenever the CPU reads this register.

Table 20: Modem Status Register bits description

Bit	Symbol	Description
7	MSR[7]	Data Carrier Detect. DCD (Active-HIGH, logical 1). Normally this bit is the complement of the $\overline{\text{DCD}}$ input. In the loop-back mode this bit is equivalent to the OUT2 bit in the MCR register.
6	MSR[6]	Ring Indicator. RI (Active-HIGH, logical 1). Normally this bit is the complement of the $\overline{\text{RI}}$ input. In the loop-back mode this bit is equivalent to the OUT1 bit in the MCR register.
5	MSR[5]	Data Set Ready. DSR (Active-HIGH, logical 1). Normally this bit is the complement of the $\overline{\text{DSR}}$ input. In loop-back mode this bit is equivalent to the DTR bit in the MCR register.
4	MSR[4]	Clear To Send. CTS. $\overline{\text{CTS}}$ functions as hardware flow control signal input if it is enabled via EFR[7]. The transmit holding register flow control is enabled/disabled by MSR[4]. Flow control (when enabled) allows starting and stopping the transmissions based on the external modem $\overline{\text{CTS}}$ signal. A logic 1 at the $\overline{\text{CTS}}$ pin will stop SC16C550 transmissions as soon as current character has finished transmission. Normally MSR[4] is the complement of the CTS input. However, in the loop-back mode, this bit is equivalent to the RTS bit in the MCR register.
3	MSR[3]	$\Delta\overline{\text{DCD}}$ [1] Logic 0 = No $\overline{\text{DCD}}$ change (normal default condition). Logic 1 = The $\overline{\text{DCD}}$ input to the SC16C550 has changed state since the last time it was read. A modem Status Interrupt will be generated.
2	MSR[2]	$\Delta\overline{\text{RI}}$ [1] Logic 0 = No $\overline{\text{RI}}$ change (normal default condition). Logic 1 = The $\overline{\text{RI}}$ input to the SC16C550 has changed from a logic 0 to a logic 1. A modem Status Interrupt will be generated.

Table 20: Modem Status Register bits description...continued

Bit	Symbol	Description
1	MSR[1]	$\Delta\overline{\text{DSR}}$ [1] Logic 0 = No $\overline{\text{DSR}}$ change (normal default condition). Logic 1 = The $\overline{\text{DSR}}$ input to the SC16C550 has changed state since the last time it was read. A modem Status Interrupt will be generated.
0	MSR[0]	$\Delta\overline{\text{CTS}}$ [1] Logic 0 = No $\overline{\text{CTS}}$ change (normal default condition). Logic 1 = The $\overline{\text{CTS}}$ input to the SC16C550 has changed state since the last time it was read. A modem Status Interrupt will be generated.

[1] Whenever any MSR bit 0-3 is set to logic 1, a Modem Status Interrupt will be generated.

7.9 Scratchpad Register (SPR)

The SC16C550 provides a temporary data register to store 8 bits of user information.

7.10 Enhanced Feature Register (EFR)

Enhanced features are enabled or disabled using this register.

Bits 0 through 4 provide single or dual character software flow control selection. When the Xon1 and Xon2 and/or Xoff1 and Xoff2 modes are selected, the double 8-bit words are concatenated into two sequential numbers.

Table 21: Enhanced Feature Register bits description

Bit	Symbol	Description
7	EFR[7]	Automatic CTS flow control. Logic 0 = Automatic CTS flow control is disabled (normal default condition). Logic 1 = Enable Automatic CTS flow control. Transmission will stop when $\overline{\text{CTS}}$ goes to a logical 1. Transmission will resume when the $\overline{\text{CTS}}$ pin returns to a logical 0.
6	EFR[6]	Automatic RTS flow control. Automatic RTS may be used for hardware flow control by enabling EFR[6]. When Auto-RTS is selected, an interrupt will be generated when the receive FIFO is filled to the programmed trigger level and $\overline{\text{RTS}}$ will go to a logic 1 at the next trigger level. $\overline{\text{RTS}}$ will return to a logic 0 when data is unloaded below the next lower trigger level (programmed trigger level 1). The state of this register bit changes with the status of the hardware flow control. RTS functions normally when hardware flow control is disabled. 0 = Automatic RTS flow control is disabled (normal default condition). 1 = Enable Automatic RTS flow control.

Table 21: Enhanced Feature Register bits description...continued

Bit	Symbol	Description
5	EFR[5]	Special Character Detect. Logic 0 = Special character detect disabled (normal default condition). Logic 1 = Special character detect enabled. The SC16C550 compares each incoming receive character with Xoff2 data. If a match exists, the received data will be transferred to FIFO and ISR[4] will be set to indicate detection of special character. Bit-0 in the X-registers corresponds with the LSB bit for the receive character. When this feature is enabled, the normal software flow control must be disabled (EFR[3-0] must be set to a logic 0).
4	EFR[4]	Enhanced function control bit. The content of IER[7-4], ISR[5-4], FCR[5-4], and MCR[7-5] can be modified and latched. After modifying any bits in the enhanced registers, EFR[4] can be set to a logic 0 to latch the new values. This feature prevents existing software from altering or overwriting the SC16C550 enhanced functions. Logic 0 = Disable (normal default condition). Logic 1 = Enable.
3-0	EFR[3-0]	Cont-3-0 Tx, Rx control. Logic 0 or cleared is the default condition. Combinations of software flow control can be selected by programming these bits. See Table 22 .

Table 22: Software flow control functions^[1]

Cont-3	Cont-2	Cont-1	Cont-0	TX, RX software flow controls
0	0	X	X	No transmit flow control
1	0	X	X	Transmit Xon1/Xoff1
0	1	X	X	Transmit Xon2/Xoff2
1	1	X	X	Transmit Xon1 and Xon2/Xoff1 and Xoff2
X	X	0	0	No receive flow control
X	X	1	0	Receiver compares Xon1/Xoff1
X	X	0	1	Receiver compares Xon2/Xoff2
1	0	1	1	Transmit Xon1/Xoff1 Receiver compares Xon1 and Xon2, Xoff1 and Xoff2
0	1	1	1	Transmit Xon2/Xoff2 Receiver compares Xon1 and Xon2/Xoff1 and Xoff2
1	1	1	1	Transmit Xon1 and Xon2/Xoff1 and Xoff2 Receiver compares Xon1 and Xon2/Xoff1 and Xoff2

[1] When using a software flow control the Xon/Xoff characters cannot be used for data transfer.

7.11 SC16C550 external reset conditions

Table 23: Reset state for registers

Register	Reset state
IER	IER[7-0] = 0
ISR	ISR[7-1] = 0; ISR[0] = 1
LCR	LCR[7-0] = 0
MCR	MCR[7-0] = 0
LSR	LSR[7] = 0; LSR[6-5] = 1; LSR[4-0] = 0
MSR	MSR[7-4] = input signals; MSR[3-0] = 0
FCR	FCR[7-0] = 0
EFR	EFR[7-0] = 0

Table 24: Reset state for outputs

Output	Reset state
TX	HIGH
$\overline{\text{RTS}}$	HIGH
$\overline{\text{DTR}}$	HIGH
$\overline{\text{RXRDY}}$	HIGH
$\overline{\text{TXRDY}}$	LOW

8. Limiting values

Table 25: Limiting values

In accordance with the Absolute Maximum Rating System (IEC 60134).

Symbol	Parameter	Conditions	Min	Max	Unit
V_{CC}	supply voltage		-	7	V
V_n	voltage at any pin		GND - 0.3	$V_{CC} + 0.3$	V
T_{amb}	operating temperature		-40	+85	°C
T_{stg}	storage temperature		-65	+150	°C
$P_{tot(pack)}$	total power dissipation per package		-	500	mW

9. Static characteristics

Table 26: DC electrical characteristics

$T_{amb} = -40\text{ }^{\circ}\text{C}$ to $+85\text{ }^{\circ}\text{C}$; $V_{CC} = 2.5\text{ V}$, 3.3 V or $5.0\text{ V} \pm 10\%$, unless otherwise specified.

Symbol	Parameter	Conditions	2.5 V		3.3 V		5.0 V		Unit
			Min	Max	Min	Max	Min	Max	
$V_{IL(CK)}$	LOW-level clock input voltage		-0.3	0.45	-0.3	0.6	-0.5	0.6	V
$V_{IH(CK)}$	HIGH-level clock input voltage		1.8	V_{CC}	2.4	V_{CC}	3.0	V_{CC}	V
V_{IL}	LOW-level input voltage		-0.3	0.65	-0.3	0.8	-0.5	0.8	V
V_{IH}	HIGH-level input voltage		1.6	-	2.0	-	2.2	V_{CC}	V
V_{OL}	LOW-level output voltage on all outputs ^[2]	$I_{OL} = 5\text{ mA}$ (databus)	-	-	-	-	-	0.4	V
		$I_{OL} = 4\text{ mA}$ (other outputs)	-	-	-	0.4	-	-	V
		$I_{OL} = 2\text{ mA}$ (databus)	-	0.4	-	-	-	-	V
		$I_{OL} = 1.6\text{ mA}$ (other outputs)	-	0.4	-	-	-	-	V
V_{OH}	HIGH-level output voltage	$I_{OH} = -5\text{ mA}$ (databus)	-	-	-	-	2.4	-	V
		$I_{OH} = -1\text{ mA}$ (other outputs)	-	-	2.0	-	-	-	V
		$I_{OH} = -800\text{ }\mu\text{A}$ (databus)	1.85	-	-	-	-	-	V
		$I_{OH} = -400\text{ }\mu\text{A}$ (other outputs)	1.85	-	-	-	-	-	V
I_{LIL}	LOW-level input leakage current		-	± 10	-	± 10	-	± 10	μA
I_{CL}	clock leakage		-	± 30	-	± 30	-	± 30	μA
I_{CC}	average power supply current	$f = 5\text{ MHz}$	-	3.5	-	4.5	-	4.5	mA
C_i	input capacitance		-	5	-	5	-	5	pF
$R_{pu(int)}$	internal pull-up resistance		500	-	500	-	500	-	k Ω

[1] Refer to [Table 2 "Pin description"](#) on page 6 for a listing of pins having internal pull-up resistors.

[2] Except for x_2 , $V_{OL} = 1\text{ V}$ typically.

10. Dynamic characteristics

Table 27: AC electrical characteristics

$T_{amb} = -40\text{ }^{\circ}\text{C}$ to $+85\text{ }^{\circ}\text{C}$; $V_{CC} = 2.5\text{ V}$, 3.3 V or $5.0\text{ V} \pm 10\%$, unless otherwise specified.

Symbol	Parameter	Conditions	2.5 V		3.3 V		5.0 V		Unit
			Min	Max	Min	Max	Min	Max	
t_{1w}, t_{2w}	clock pulse duration		15	-	13	-	10	-	ns
t_{3w}	clock frequency	[1]	-	16	-	32	-	48	MHz
t_{4w}	address strobe width		45	-	35	-	25	-	ns
t_{5s}	address set-up time		5	-	5	-	1	-	ns
t_{5h}	address hold time		5	-	5	-	5	-	ns
t_{6s}	chip select set-up time to \overline{AS}		10	-	5	-	0	-	ns
t_{6h}	address hold time		0	-	0	-	0	-	ns
$t_{6s'}$	address set-up time	[2]	10	-	10	-	5	-	ns
t_{6h}	chip select hold time		0	-	0	-	0	-	ns
t_{7d}	\overline{IOR} delay from chip select		10	-	10	-	10	-	ns
t_{7w}	\overline{IOR} strobe width	25 pF load	77	-	26	-	23	-	ns
t_{7h}	chip select hold time from \overline{IOR}		0	-	0	-	0	-	ns
$t_{7h'}$	address hold time	[2]	5	-	5	-	5	-	ns
t_{8d}	\overline{IOR} delay from address		10	-	10	-	10	-	ns
t_{9d}	read cycle delay	25 pF load	20	-	20	-	20	-	ns
t_{11d}	\overline{IOR} to \overline{DDIS} delay	25 pF load	-	100	-	35	-	30	ns
t_{12d}	delay from \overline{IOR} to data	25 pF load	-	77	-	26	-	23	ns
t_{12h}	data disable time	25 pF load	-	15	-	15	-	15	ns
t_{13d}	\overline{IOW} delay from chip select		10	-	10	-	10	-	ns
t_{13w}	\overline{IOW} strobe width	[3]	20	-	20	-	15	-	ns
t_{13h}	chip select hold time from \overline{IOW}		0	-	0	-	0	-	ns
t_{14d}	\overline{IOW} delay from address		10	-	10	-	10	-	ns
t_{15d}	write cycle delay	[4]	25	-	25	-	20	-	ns
t_{16s}	data set-up time		20	-	20	-	15	-	ns
t_{16h}	data hold time		15	-	5	-	5	-	ns
t_{17d}	delay from \overline{IOW} to output	25 pF load	-	100	-	33	-	29	ns
t_{18d}	delay to set interrupt from Modem input	25 pF load	-	100	-	24	-	23	ns
t_{19d}	delay to reset interrupt from \overline{IOR}	25 pF load	-	100	-	24	-	23	ns
t_{20d}	delay from stop to set interrupt		-	1	-	1	-	1	R_{clk}
t_{21d}	delay from \overline{IOR} to reset interrupt	25 pF load	-	100	-	29	-	28	ns
t_{22d}	delay from start to set interrupt		-	100	-	45	-	40	ns
t_{23d}	delay from \overline{IOW} to transmit start		8	24	8	24	8	24	R_{clk}
t_{24d}	delay from \overline{IOW} to reset interrupt		-	100	-	45	-	40	ns
t_{25d}	delay from stop to set \overline{RXRDY}		-	1	-	1	-	1	R_{clk}
t_{26d}	delay from \overline{IOR} to reset \overline{RXRDY}		-	100	-	45	-	40	ns
t_{27d}	delay from \overline{IOW} to set \overline{TXRDY}		-	100	-	45	-	40	ns

Table 27: AC electrical characteristics...continued

$T_{amb} = -40^{\circ}\text{C}$ to $+85^{\circ}\text{C}$; $V_{CC} = 2.5\text{ V}, 3.3\text{ V}$ or $5.0\text{ V} \pm 10\%$, unless otherwise specified.

Symbol	Parameter	Conditions	2.5 V		3.3 V		5.0 V		Unit
			Min	Max	Min	Max	Min	Max	
t_{28d}	delay from start to reset $\overline{\text{TXRDY}}$		-	8	-	8	-	8	R_{clk}
t_{RESET}	Reset pulse width		100	-	40	-	40	-	ns
N	baud rate divisor		1	$2^{16} - 1$	1	$2^{16} - 1$	1	$2^{16} - 1$	R_{clk}

[1] Applies to external clock, crystal oscillator max 24 MHz.

[2] Applicable only when $\overline{\text{AS}}$ is tied LOW.

[3]
$$\overline{\text{IOW}}_{\text{strobe}_{max}} = \frac{1}{2(\text{Baudrate}_{max})}$$

= 333 ns (for $\text{Baudrate}_{max} = 1.5\text{ Mbits/s}$)

= 1 μs (for $\text{Baudrate}_{max} = 460.8\text{ kbits/s}$)

= 4 μs (for $\text{Baudrate}_{max} = 115.2\text{ kbits/s}$)

[4] When in **both** DMA mode 0 **and** FIFO enable mode, the write cycle delay should be larger than one x_1 clock cycle.

10.1 Timing diagrams

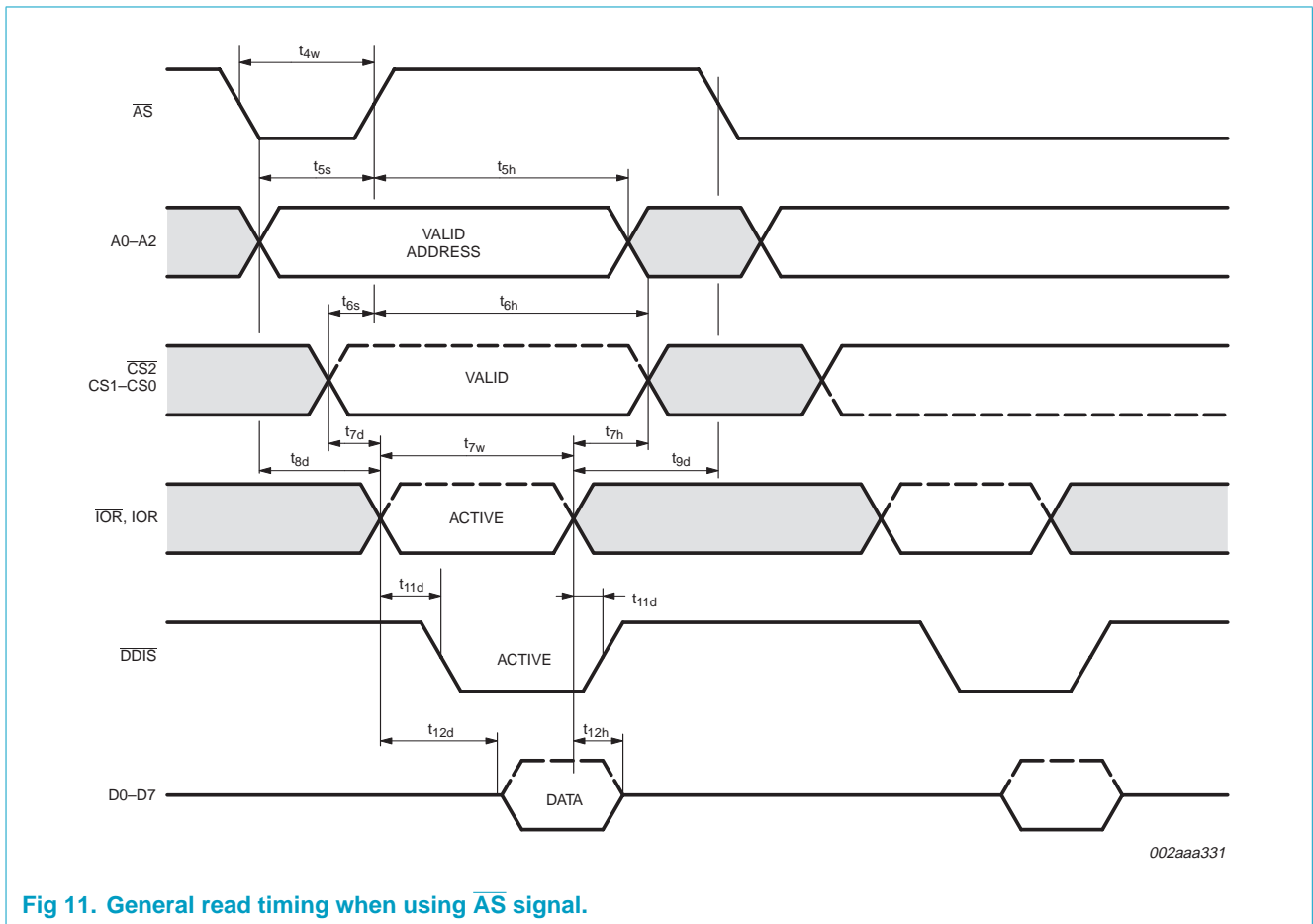
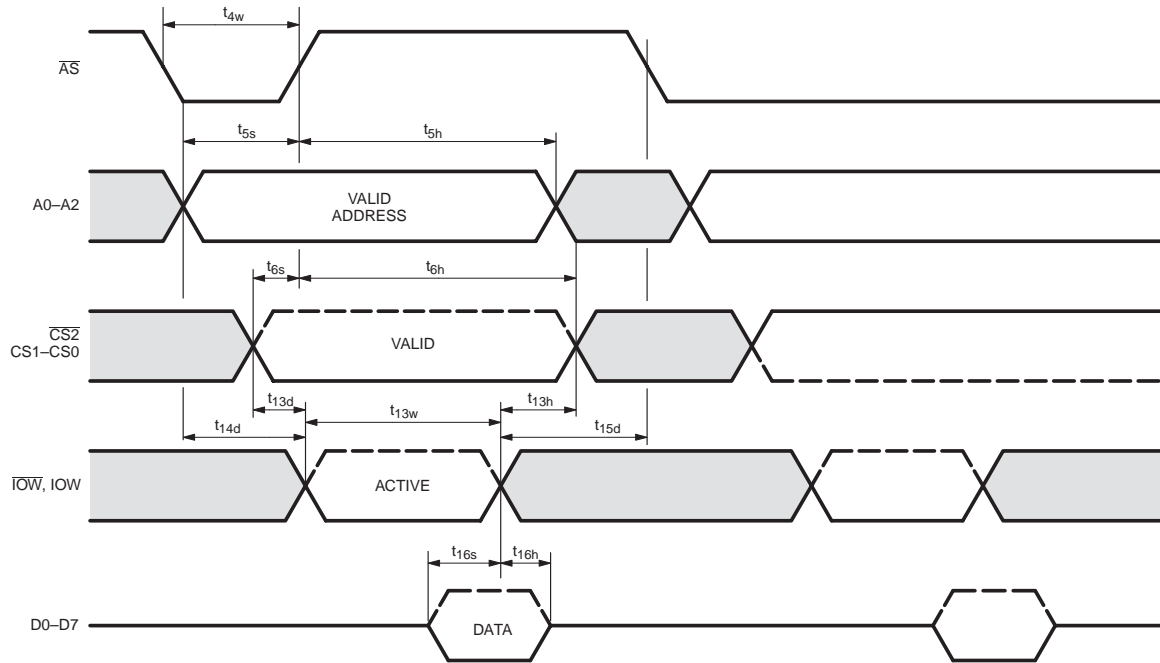
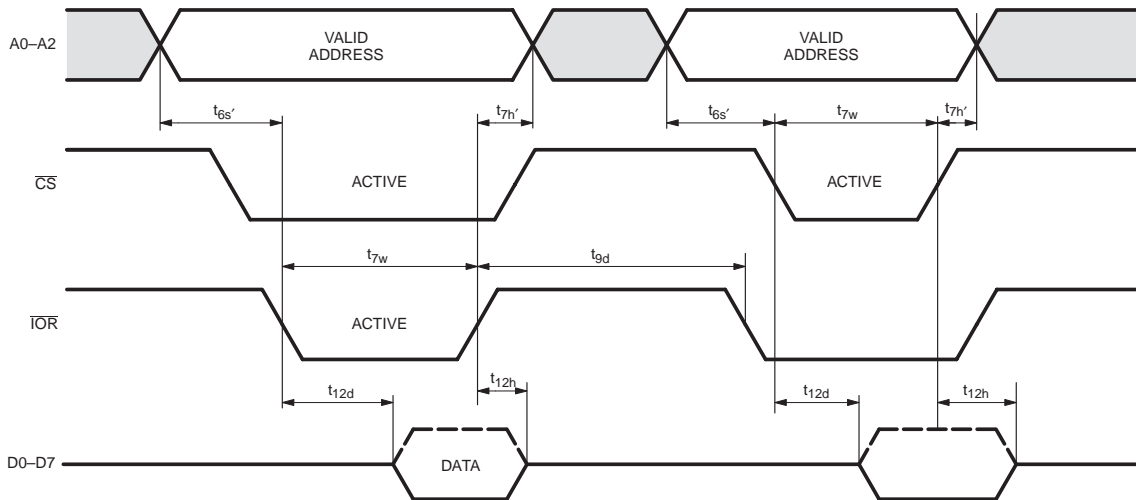

Fig 11. General read timing when using $\overline{\text{AS}}$ signal.



002aaa332

Fig 12. General write timing when using \overline{AS} signal.



002aaa333

Fig 13. General read timing when \overline{AS} is tied to GND.

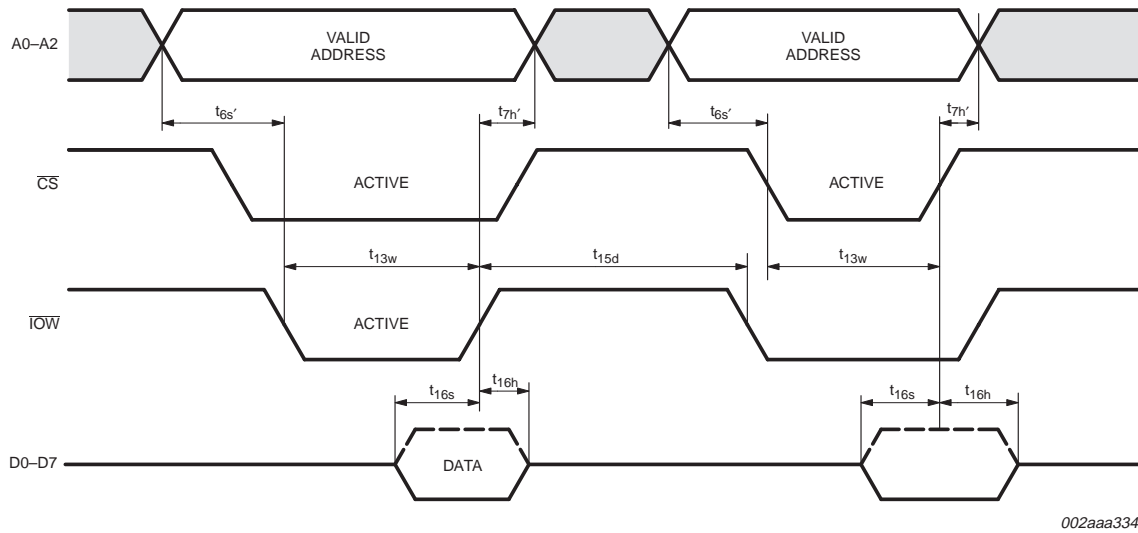

Fig 14. General write timing when \overline{AS} is tied to GND.

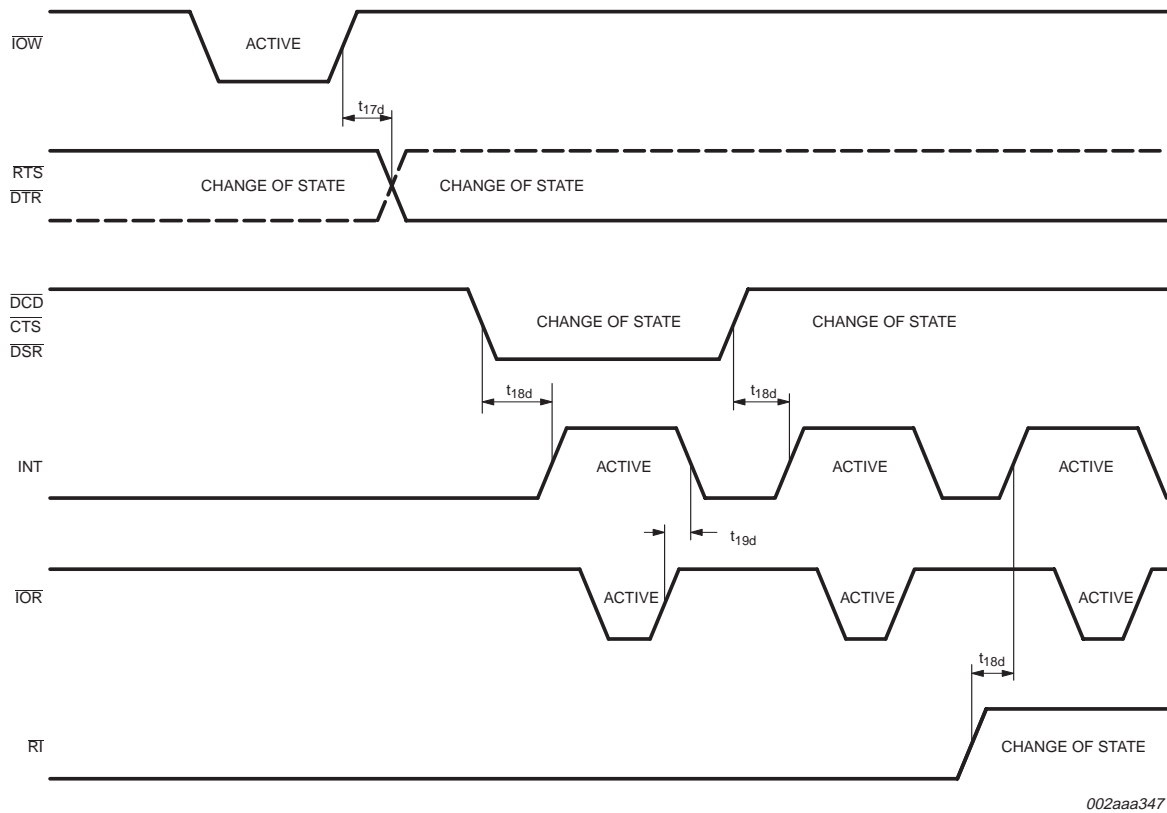

Fig 15. Modem input/output timing.

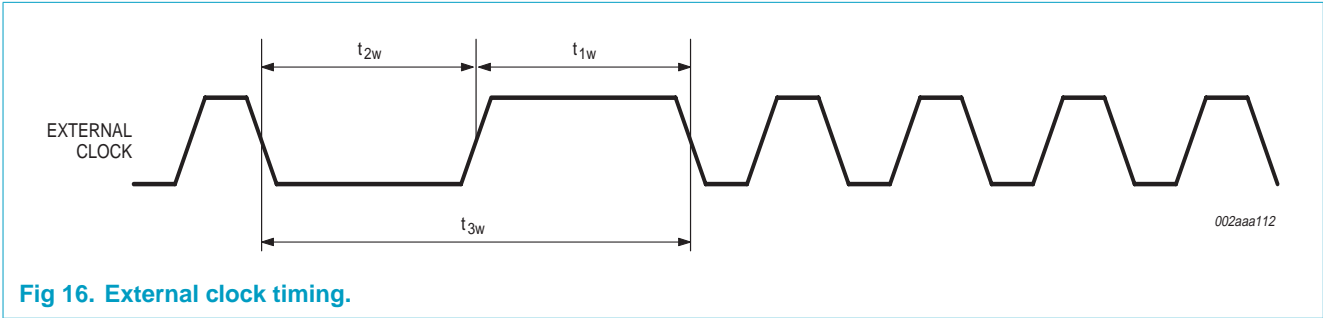

Fig 16. External clock timing.

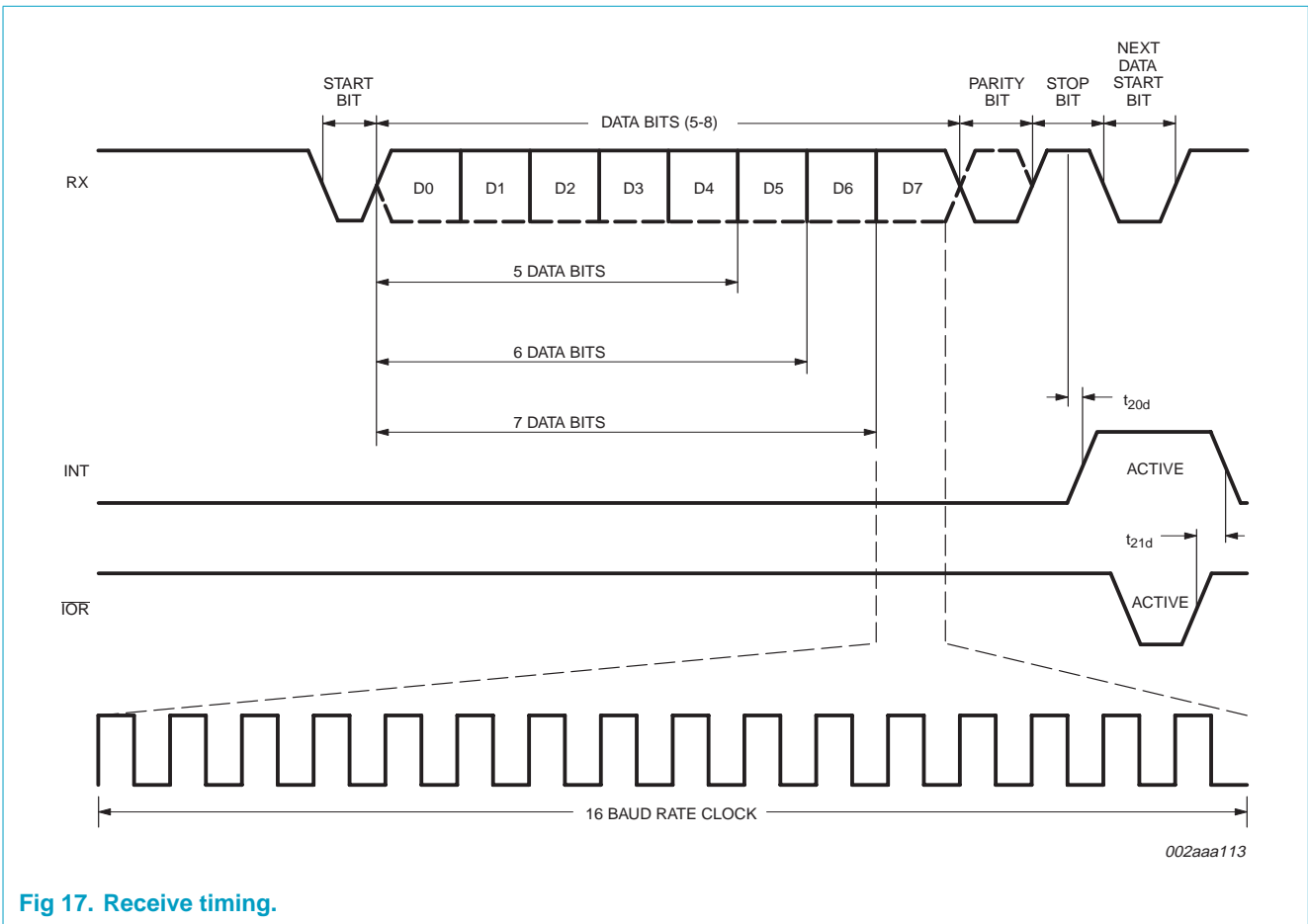

Fig 17. Receive timing.

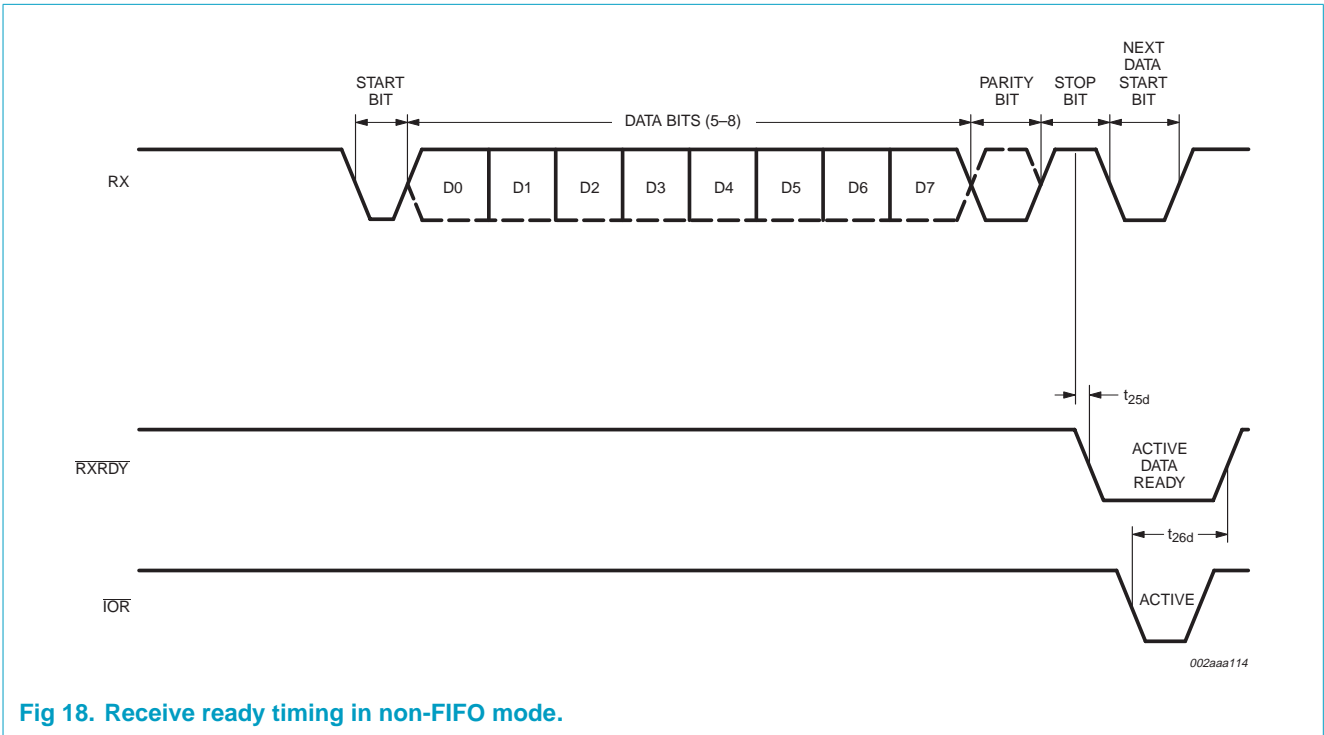

Fig 18. Receive ready timing in non-FIFO mode.

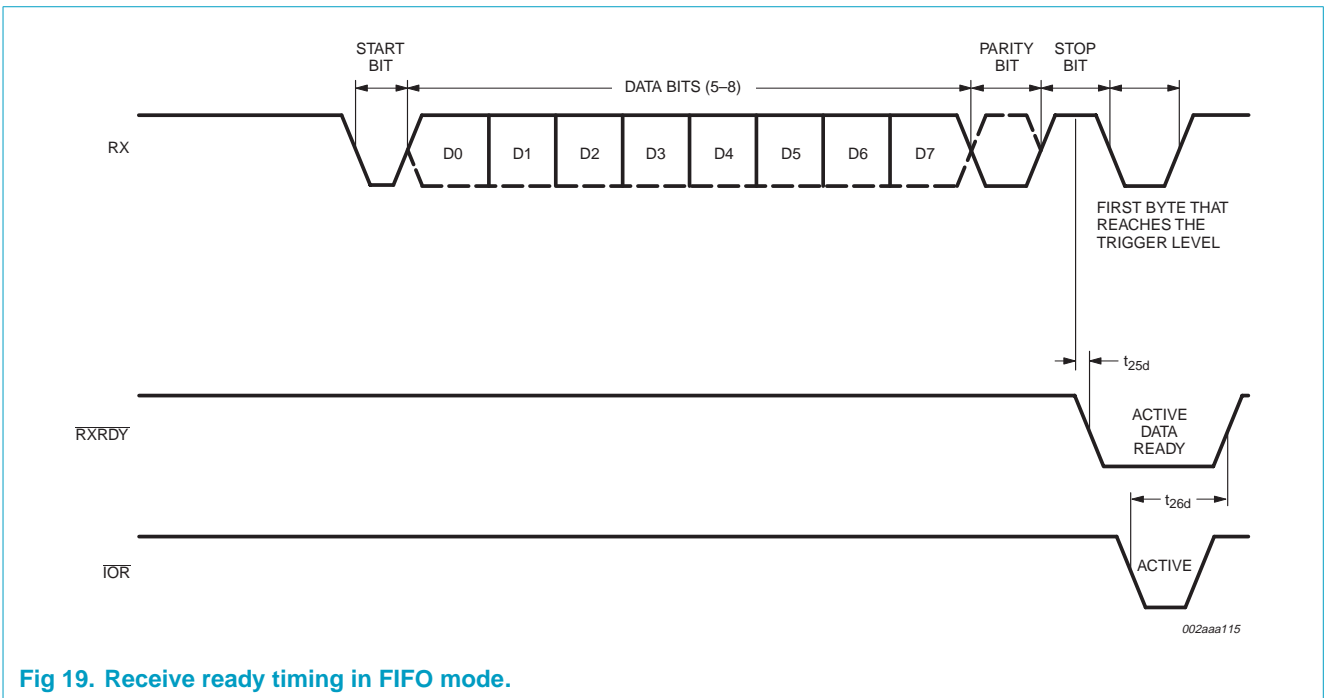

Fig 19. Receive ready timing in FIFO mode.

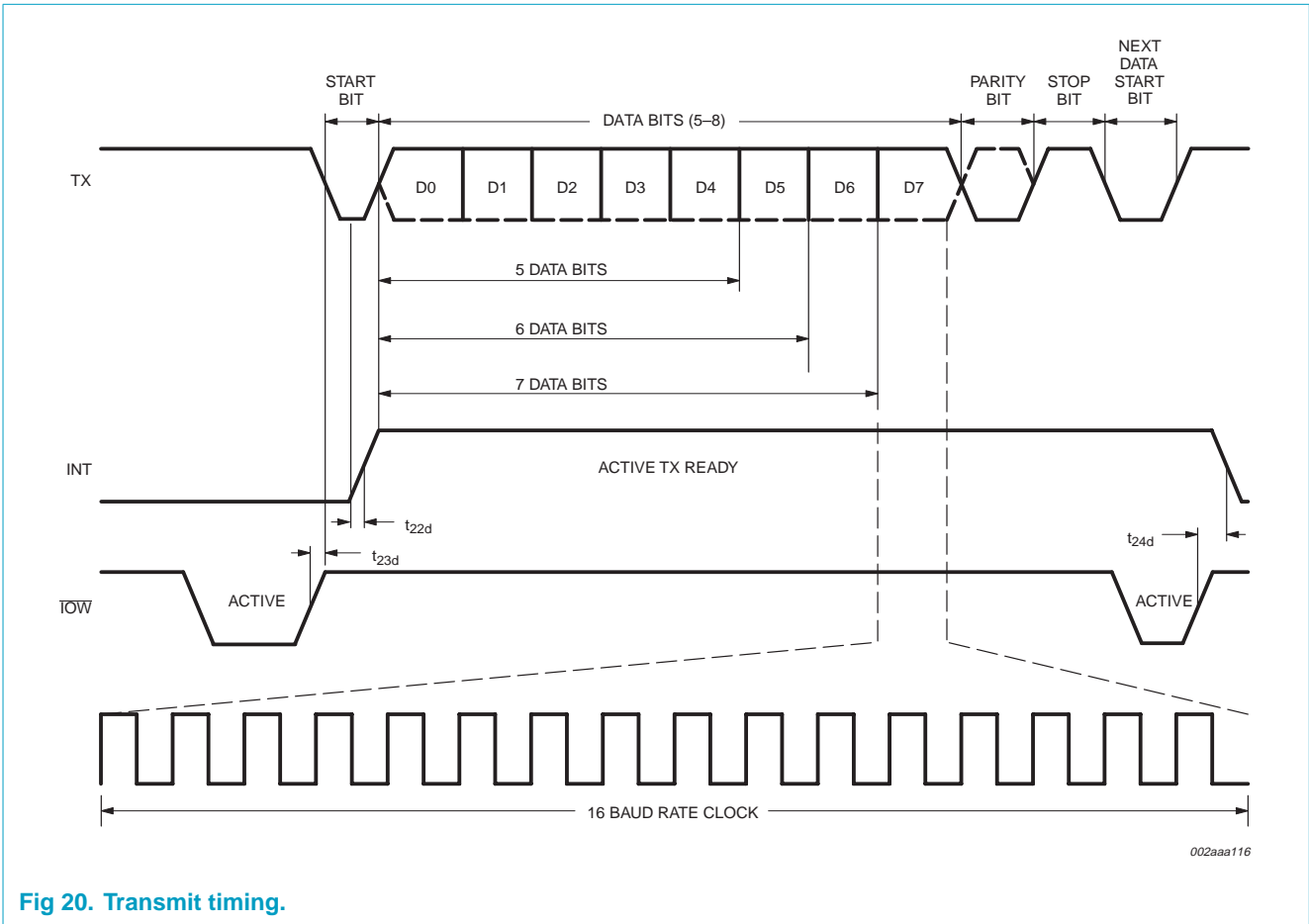

Fig 20. Transmit timing.

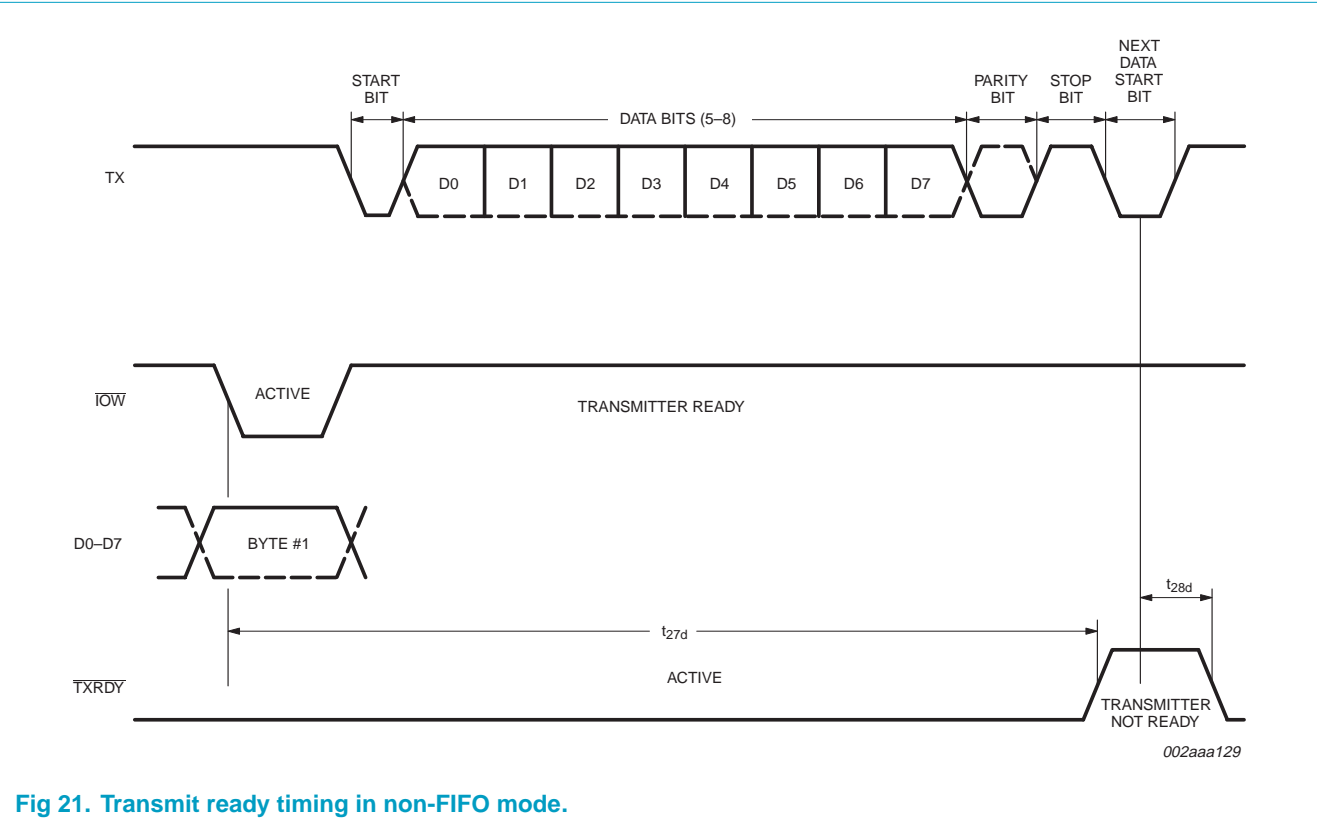
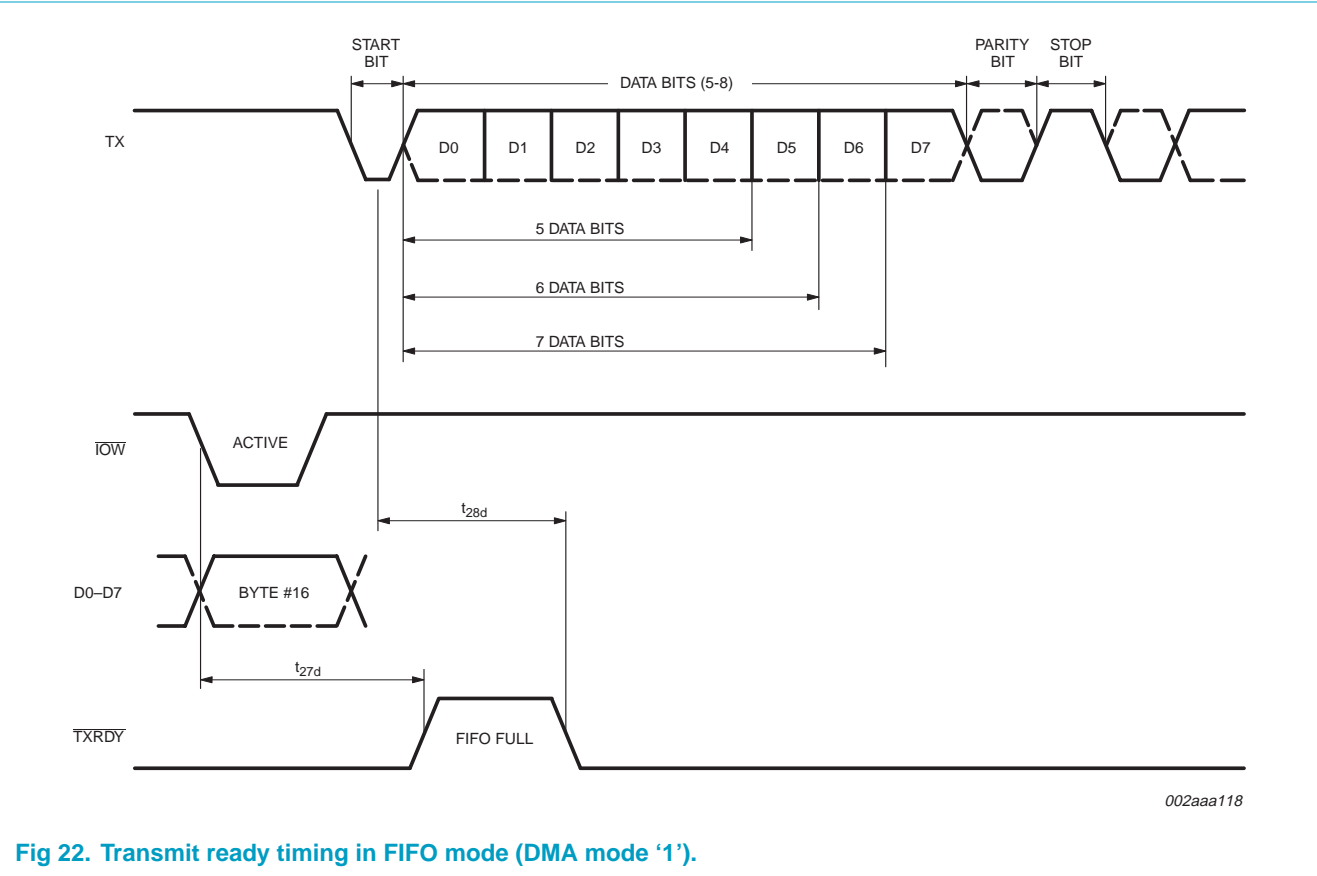

Fig 21. Transmit ready timing in non-FIFO mode.



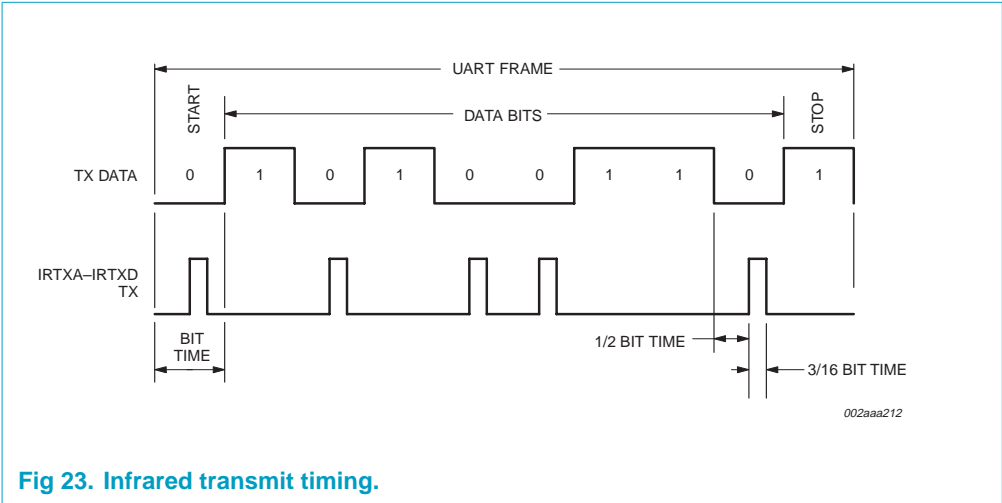

Fig 23. Infrared transmit timing.

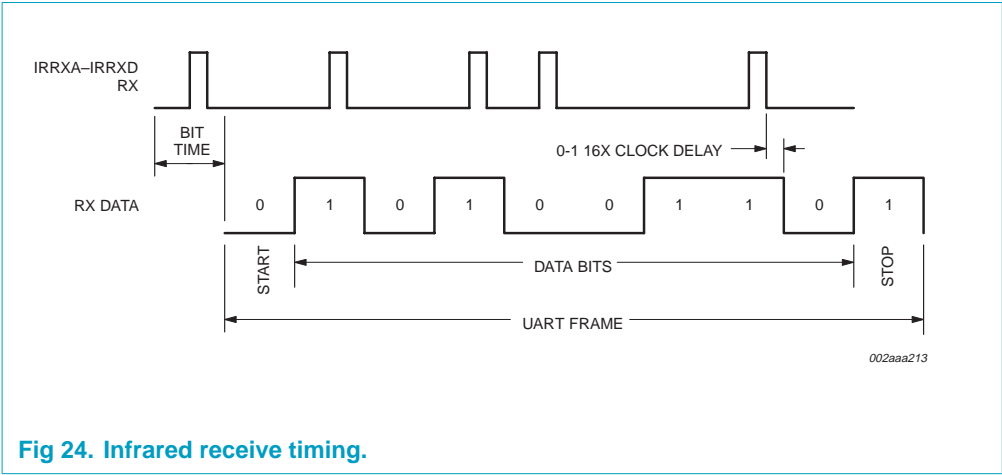

Fig 24. Infrared receive timing.

11. Package outline

PLCC44: plastic leaved chip carrier; 44 leads

SOT187-2

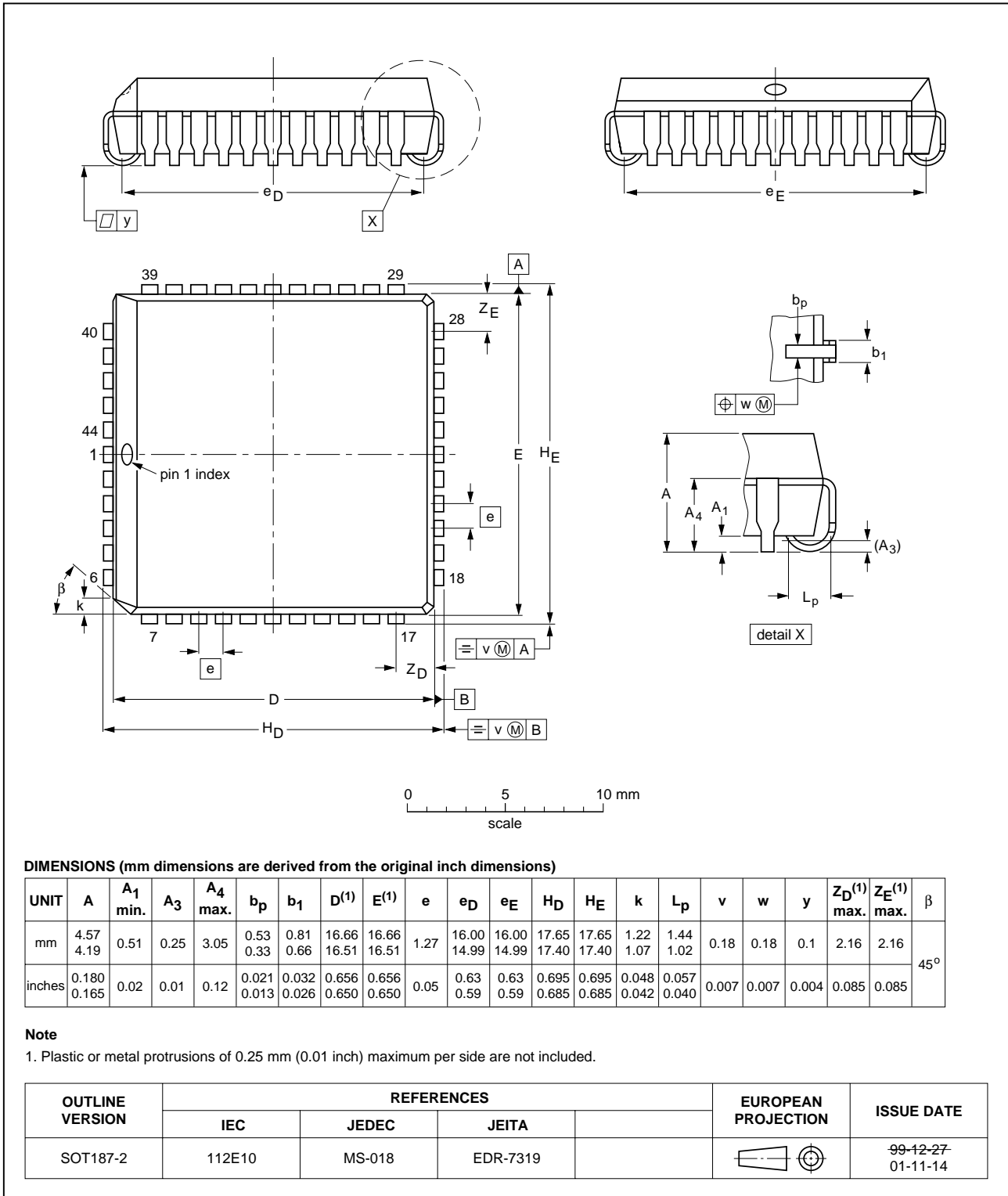

Fig 25. PLCC44 (SOT187-2).

LQFP48: plastic low profile quad flat package; 48 leads; body 7 x 7 x 1.4 mm

SOT313-2

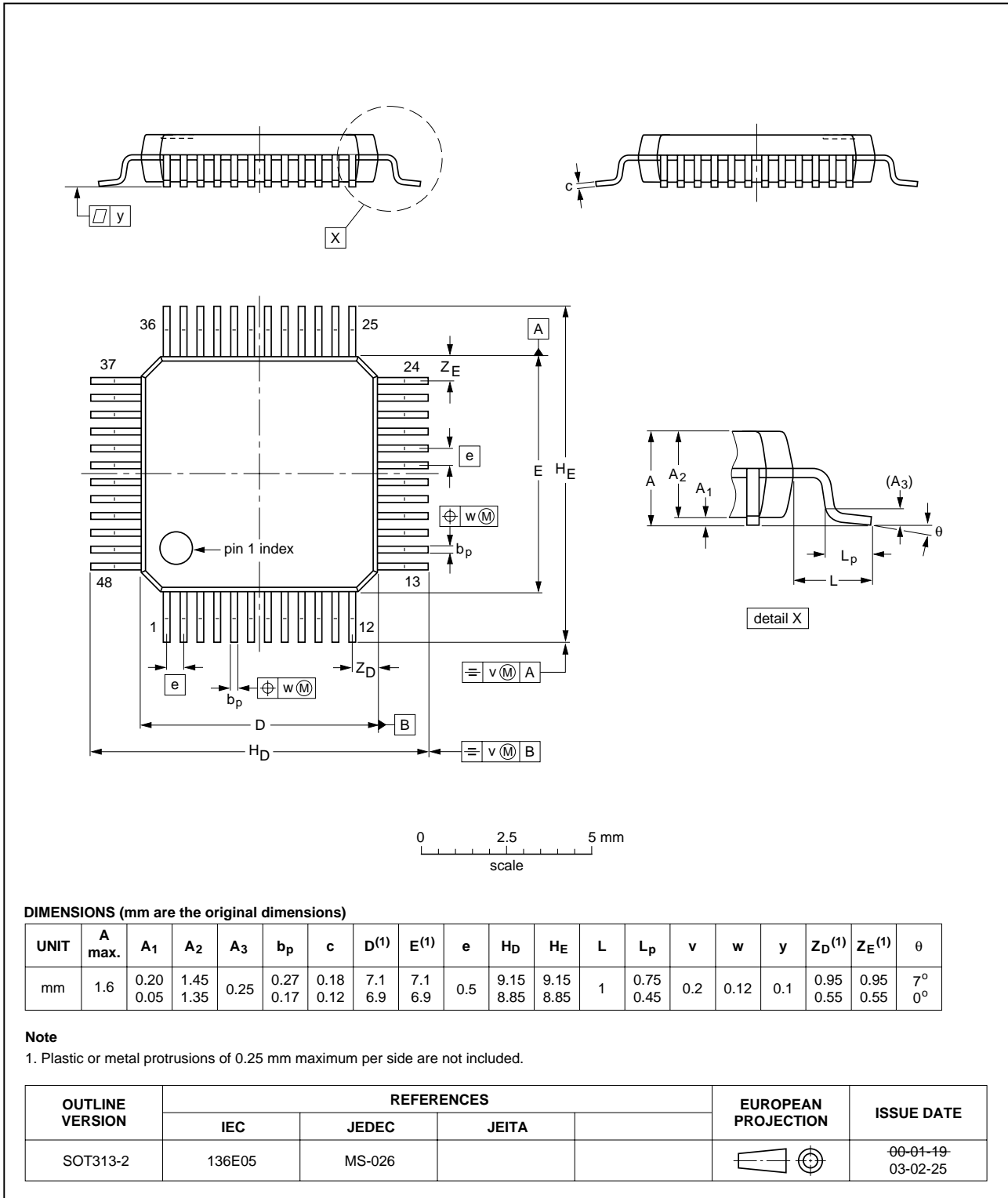

Fig 26. LQFP48 (SOT313-2).

DIP40: plastic dual in-line package; 40 leads (600 mil)

SOT129-1

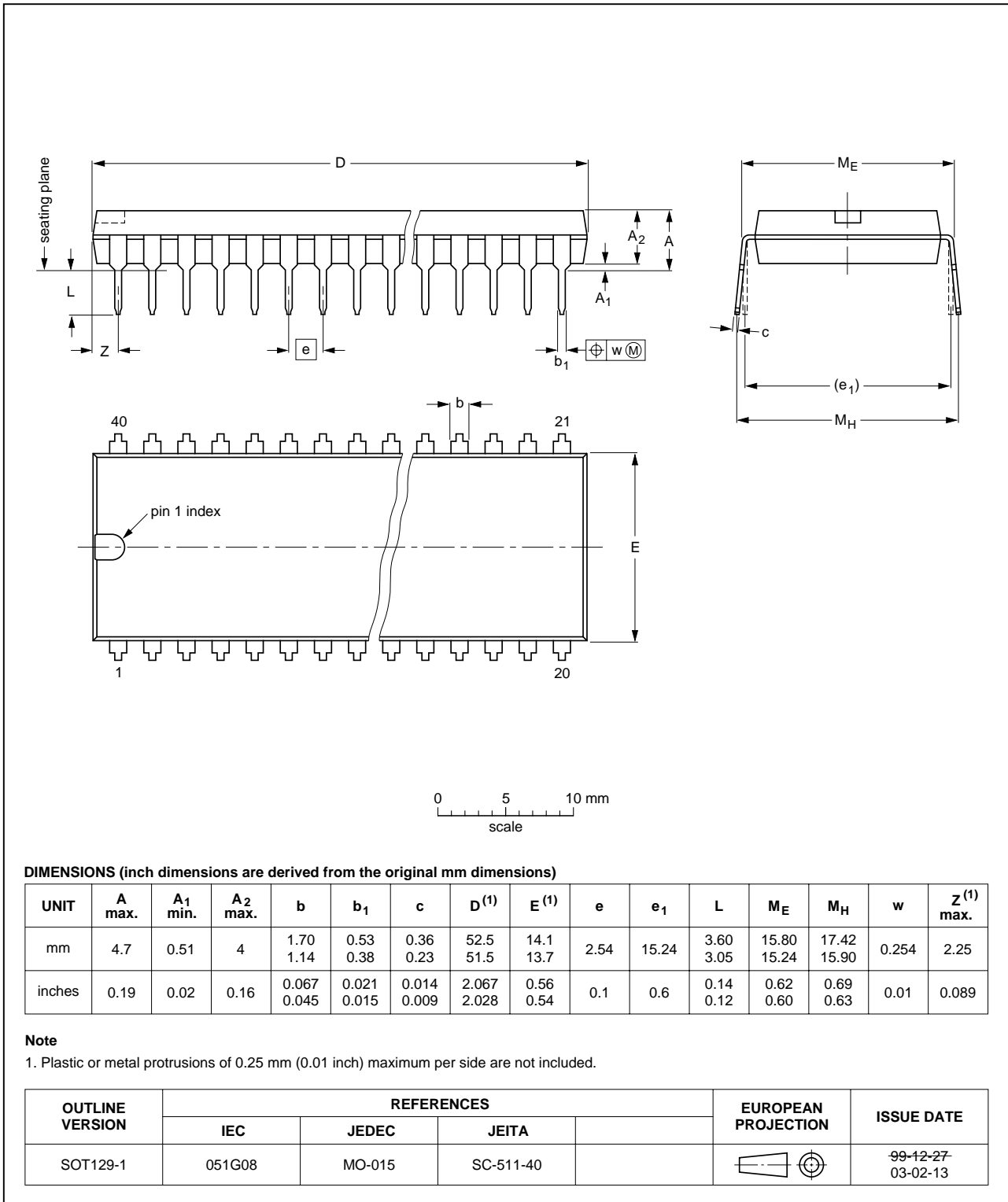

Fig 27. DIP40 (SOT129-1).

12. Soldering

12.1 Introduction

This text gives a very brief insight to a complex technology. A more in-depth account of soldering ICs can be found in our *Data Handbook IC26; Integrated Circuit Packages* (document order number 9398 652 90011).

There is no soldering method that is ideal for all IC packages. Wave soldering is often preferred when through-hole and surface mount components are mixed on one printed-circuit board. Wave soldering can still be used for certain surface mount ICs, but it is not suitable for fine pitch SMDs. In these situations reflow soldering is recommended. Driven by legislation and environmental forces the worldwide use of lead-free solder pastes is increasing.

12.2 Through-hole mount packages

12.2.1 Soldering by dipping or by solder wave

Typical dwell time of the leads in the wave ranges from 3 to 4 seconds at 250 °C or 265 °C, depending on solder material applied, SnPb or Pb-free respectively.

The total contact time of successive solder waves must not exceed 5 seconds.

The device may be mounted up to the seating plane, but the temperature of the plastic body must not exceed the specified maximum storage temperature ($T_{stg(max)}$). If the printed-circuit board has been pre-heated, forced cooling may be necessary immediately after soldering to keep the temperature within the permissible limit.

12.2.2 Manual soldering

Apply the soldering iron (24 V or less) to the lead(s) of the package, either below the seating plane or not more than 2 mm above it. If the temperature of the soldering iron bit is less than 300 °C it may remain in contact for up to 10 seconds. If the bit temperature is between 300 and 400 °C, contact may be up to 5 seconds.

12.3 Surface mount packages

12.3.1 Reflow soldering

Reflow soldering requires solder paste (a suspension of fine solder particles, flux and binding agent) to be applied to the printed-circuit board by screen printing, stencilling or pressure-syringe dispensing before package placement.

Several methods exist for reflowing; for example, convection or convection/infrared heating in a conveyor type oven. Throughput times (preheating, soldering and cooling) vary between 100 and 200 seconds depending on heating method.

Typical reflow peak temperatures range from 215 to 270 °C depending on solder paste material. The top-surface temperature of the packages should preferably be kept:

- below 220 °C (SnPb process) or below 245 °C (Pb-free process)
 - for all the BGA and SSOP-T packages

- for packages with a thickness ≥ 2.5 mm
- for packages with a thickness < 2.5 mm and a volume ≥ 350 mm³ so called thick/large packages.
- below 235 °C (SnPb process) or below 260 °C (Pb-free process) for packages with a thickness < 2.5 mm and a volume < 350 mm³ so called small/thin packages.

Moisture sensitivity precautions, as indicated on packing, must be respected at all times.

12.3.2 Wave soldering

Conventional single wave soldering is not recommended for surface mount devices (SMDs) or printed-circuit boards with a high component density, as solder bridging and non-wetting can present major problems.

To overcome these problems the double-wave soldering method was specifically developed.

If wave soldering is used the following conditions must be observed for optimal results:

- Use a double-wave soldering method comprising a turbulent wave with high upward pressure followed by a smooth laminar wave.
- For packages with leads on two sides and a pitch (e):
 - larger than or equal to 1.27 mm, the footprint longitudinal axis is **preferred** to be parallel to the transport direction of the printed-circuit board;
 - smaller than 1.27 mm, the footprint longitudinal axis **must** be parallel to the transport direction of the printed-circuit board.

The footprint must incorporate solder thieves at the downstream end.

- For packages with leads on four sides, the footprint must be placed at a 45° angle to the transport direction of the printed-circuit board. The footprint must incorporate solder thieves downstream and at the side corners.

During placement and before soldering, the package must be fixed with a droplet of adhesive. The adhesive can be applied by screen printing, pin transfer or syringe dispensing. The package can be soldered after the adhesive is cured.

Typical dwell time of the leads in the wave ranges from 3 to 4 seconds at 250 °C or 265 °C, depending on solder material applied, SnPb or Pb-free respectively.

A mildly-activated flux will eliminate the need for removal of corrosive residues in most applications.

12.3.3 Manual soldering

Fix the component by first soldering two diagonally-opposite end leads. Use a low voltage (24 V or less) soldering iron applied to the flat part of the lead. Contact time must be limited to 10 seconds at up to 300 °C.

When using a dedicated tool, all other leads can be soldered in one operation within 2 to 5 seconds between 270 and 320 °C.

12.4 Package related soldering information

Table 28: Suitability of IC packages for wave, reflow and dipping soldering methods

Mounting	Package ^[1]	Soldering method		
		Wave	Reflow ^[2]	Dipping
Through-hole mount	DBS, DIP, HDIP, SDIP, SIL	suitable ^[3]	–	suitable
Surface mount	BGA, LBGA, LFBGA, SQFP, SSOP-T ^[4] , TFBGA, VFBGA	not suitable	suitable	–
	DHVQFN, HBCC, HBGA, HLQFP, HSQFP, HSOP, HTQFP, HTSSOP, HVQFN, HVSON, SMS	not suitable ^[5]	suitable	–
	PLCC ^[6] , SO, SOJ	suitable	suitable	–
	LQFP, QFP, TQFP	not recommended ^{[6][7]}	suitable	–
	SSOP, TSSOP, VSO, VSSOP	not recommended ^[8]	suitable	–

- [1] For more detailed information on the BGA packages refer to the *(LF)BGA Application Note* (AN01026); order a copy from your Philips Semiconductors sales office.
- [2] All surface mount (SMD) packages are moisture sensitive. Depending upon the moisture content, the maximum temperature (with respect to time) and body size of the package, there is a risk that internal or external package cracks may occur due to vaporization of the moisture in them (the so called popcorn effect). For details, refer to the Drypack information in the *Data Handbook IC26; Integrated Circuit Packages; Section: Packing Methods*.
- [3] For SDIP packages, the longitudinal axis must be parallel to the transport direction of the printed-circuit board.
- [4] These transparent plastic packages are extremely sensitive to reflow soldering conditions and must on no account be processed through more than one soldering cycle or subjected to infrared reflow soldering with peak temperature exceeding $217\text{ °C} \pm 10\text{ °C}$ measured in the atmosphere of the reflow oven. The package body peak temperature must be kept as low as possible.
- [5] These packages are not suitable for wave soldering. On versions with the heatsink on the bottom side, the solder cannot penetrate between the printed-circuit board and the heatsink. On versions with the heatsink on the top side, the solder might be deposited on the heatsink surface.
- [6] If wave soldering is considered, then the package must be placed at a 45° angle to the solder wave direction. The package footprint must incorporate solder thieves downstream and at the side corners.
- [7] Wave soldering is suitable for LQFP, QFP and TQFP packages with a pitch (e) larger than 0.8 mm; it is definitely not suitable for packages with a pitch (e) equal to or smaller than 0.65 mm.
- [8] Wave soldering is suitable for SSOP and TSSOP packages with a pitch (e) equal to or larger than 0.65 mm; it is definitely not suitable for packages with a pitch (e) equal to or smaller than 0.5 mm.

13. Revision history

Table 29: Revision history

Rev	Date	CPCN	Description
05	20030619	-	Product data (9397 750 11619); ECN 853-2366 30027 of 16 June 2003. Modifications: <ul style="list-style-type: none">• Figure 9 “Crystal oscillator connection.” on page 15: changed capacitors' values and added connection with resistor.
04	20030313	-	Product data (9397 750 11206); ECN 853-2366 29626 of 10 March 2003.
03	20030221	-	Product data (9397 750 10826); ECN 853-2366 29261 of 06 December 2002.
02	20021030	-	Product data (9397 750 10627); ECN 853-2366 29108 of 24 October 2002.
01	20020904	-	Product data (9397 750 09836); ECN 853-2366 28865 of 04 September 2002.

14. Data sheet status

Level	Data sheet status ^[1]	Product status ^{[2],[3]}	Definition
I	Objective data	Development	This data sheet contains data from the objective specification for product development. Philips Semiconductors reserves the right to change the specification in any manner without notice.
II	Preliminary data	Qualification	This data sheet contains data from the preliminary specification. Supplementary data will be published at a later date. Philips Semiconductors reserves the right to change the specification without notice, in order to improve the design and supply the best possible product.
III	Product data	Production	This data sheet contains data from the product specification. Philips Semiconductors reserves the right to make changes at any time in order to improve the design, manufacturing and supply. Relevant changes will be communicated via a Customer Product/Process Change Notification (CPCN).

[1] Please consult the most recently issued data sheet before initiating or completing a design.

[2] The product status of the device(s) described in this data sheet may have changed since this data sheet was published. The latest information is available on the Internet at URL <http://www.semiconductors.philips.com>.

[3] For data sheets describing multiple type numbers, the highest-level product status determines the data sheet status.

15. Definitions

Short-form specification — The data in a short-form specification is extracted from a full data sheet with the same type number and title. For detailed information see the relevant data sheet or data handbook.

Limiting values definition — Limiting values given are in accordance with the Absolute Maximum Rating System (IEC 60134). Stress above one or more of the limiting values may cause permanent damage to the device. These are stress ratings only and operation of the device at these or at any other conditions above those given in the Characteristics sections of the specification is not implied. Exposure to limiting values for extended periods may affect device reliability.

Application information — Applications that are described herein for any of these products are for illustrative purposes only. Philips Semiconductors make no representation or warranty that such applications will be suitable for the specified use without further testing or modification.

16. Disclaimers

Life support — These products are not designed for use in life support appliances, devices, or systems where malfunction of these products can reasonably be expected to result in personal injury. Philips Semiconductors customers using or selling these products for use in such applications do so at their own risk and agree to fully indemnify Philips Semiconductors for any damages resulting from such application.

Right to make changes — Philips Semiconductors reserves the right to make changes in the products - including circuits, standard cells, and/or software - described or contained herein in order to improve design and/or performance. When the product is in full production (status 'Production'), relevant changes will be communicated via a Customer Product/Process Change Notification (CPCN). Philips Semiconductors assumes no responsibility or liability for the use of any of these products, conveys no licence or title under any patent, copyright, or mask work right to these products, and makes no representations or warranties that these products are free from patent, copyright, or mask work right infringement, unless otherwise specified.

Contact information

For additional information, please visit <http://www.semiconductors.philips.com>.

For sales office addresses, send e-mail to: sales.addresses@www.semiconductors.philips.com.

Fax: +31 40 27 24825

Contents

1	General description	1	8	Limiting values	32
2	Features	1	9	Static characteristics	33
3	Ordering information	2	10	Dynamic characteristics	34
4	Block diagram	3	10.1	Timing diagrams	35
5	Pinning information	4	11	Package outline	44
5.1	Pinning	4	12	Soldering	47
5.2	Pin description	6	12.1	Introduction	47
6	Functional description	9	12.2	Through-hole mount packages	47
6.1	Internal registers	10	12.2.1	Soldering by dipping or by solder wave	47
6.2	FIFO operation	10	12.2.2	Manual soldering	47
6.3	Autoflow control (see Figure 5)	11	12.3	Surface mount packages	47
6.3.1	Auto-RTS (see Figure 5)	11	12.3.1	Reflow soldering	47
6.3.2	Auto-CTS (see Figure 5)	12	12.3.2	Wave soldering	48
6.3.3	Enabling autoflow control and auto-CTS	12	12.3.3	Manual soldering	48
6.3.4	Auto-CTS and auto-RTS functional timing	12	12.4	Package related soldering information	49
6.4	Software flow control	13	13	Revision history	50
6.5	Special feature software flow control	14	14	Data sheet status	51
6.6	Hardware/software and time-out interrupts	14	15	Definitions	51
6.7	Programmable baud rate generator	15	16	Disclaimers	51
6.8	DMA operation	16			
6.9	Sleep mode	17			
6.10	Loop-back mode	17			
7	Register descriptions	19			
7.1	Transmit (THR) and Receive (RHR) Holding Registers	20			
7.2	Interrupt Enable Register (IER)	20			
7.2.1	IER versus Receive FIFO interrupt mode operation	21			
7.2.2	IER versus Receive/Transmit FIFO polled mode operation	21			
7.3	FIFO Control Register (FCR)	22			
7.3.1	DMA mode	22			
7.3.2	FIFO mode	22			
7.4	Interrupt Status Register (ISR)	24			
7.5	Line Control Register (LCR)	25			
7.6	Modem Control Register (MCR)	27			
7.7	Line Status Register (LSR)	28			
7.8	Modem Status Register (MSR)	29			
7.9	Scratchpad Register (SPR)	30			
7.10	Enhanced Feature Register (EFR)	30			
7.11	SC16C550 external reset conditions	32			



PHILIPS

Let's make things better.