



Low-Cost, Micropower, High-Side Current-Sense Amplifier + Comparator + Reference ICs

General Description

The MAX4373/MAX4374/MAX4375 low-cost, micropower, high-side current-sense supervisors contain a high-side current-sense amplifier, bandgap reference, and comparator with latching output. They feature a voltage output that eliminates the need for gain-setting resistors, making them ideal for today's notebook computers, cell phones, and other systems where battery/DC current monitoring is critical. High-side current monitoring is especially useful in battery-powered systems since it does not interfere with the ground path of the battery charger. The 0 to +28V input common-mode range is independent of the supply voltage, which ensures that the current-sense feedback remains viable even when connected to a battery pack in deep discharge.

The comparator output of the MAX4373/MAX4374/MAX4375 is latched to provide a turn-off flag that doesn't oscillate. In addition, the MAX4374/MAX4375 contain a second comparator for use in window-detection functions. The MAX4373/MAX4374/MAX4375 are available in three different gain versions (T = +20V/V, F = +50V/V, H = +100V/V) and use an external sense resistor to set the sensitivity of the input voltage to the load current. These features offer a high level of integration, resulting in a simple and compact current-sense solution.

The MAX4373/MAX4374/MAX4375 operate from a single +2.7V to +28V supply and consume 50 μ A. They are specified for the extended operating temperature range (-40°C to +85°C) and are available in 8-pin and 10-pin μ MAX packages.

Applications

- Notebook Computers
- Portable/Battery-Powered Systems
- Smart Battery Packs/Chargers
- Cell Phones
- Power-Management Systems
- General-System/Board-Level Current Monitoring
- Precision Current Sources

Pin Configurations appear at end of data sheet.

Features

- ◆ Current-Sense Amplifier plus Internal Comparator and Bandgap Reference
- ◆ 50 μ A Supply Current
- ◆ Single +2.7V to +28V Operating Supply
- ◆ 0.66% Full-Scale Accuracy
- ◆ Internal Bandgap Reference
- ◆ Latching Comparator Output
- ◆ Three Gain Versions Available (+20V/V, +50V/V, +100V/V)
- ◆ Wide 0 to +28V Common-Mode Range, Independent of Supply Voltage

Ordering Information

PART	TEMP. RANGE	PIN-PACKAGE	GAIN (V/V)
MAX4373TEUA	-40°C to +85°C	8 μ MAX	+20
MAX4373TESA	-40°C to +85°C	8 SO	+20
MAX4373FEUA	-40°C to +85°C	8 μ MAX	+50
MAX4373FESA	-40°C to +85°C	8 SO	+50
MAX4373HEUA	-40°C to +85°C	8 μ MAX	+100
MAX4373HESA	-40°C to +85°C	8 SO	+100

Ordering Information continued at end of data sheet.

Typical Operating Circuit

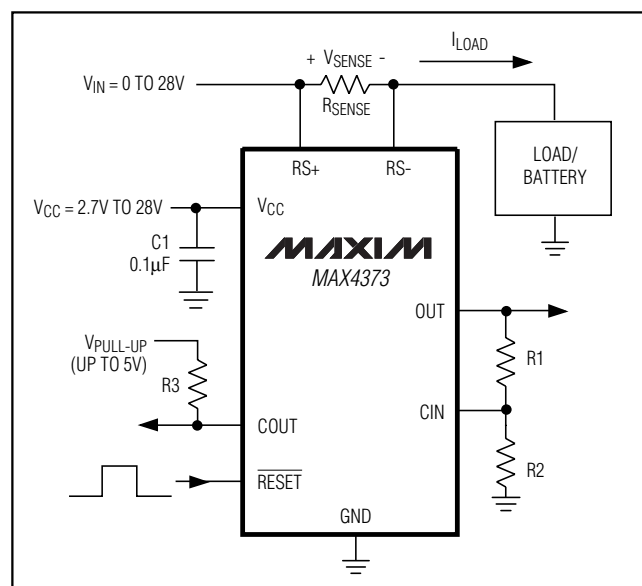

Low-Cost, Micropower, High-Side Current-Sense Amplifier + Comparator + Reference ICs

ABSOLUTE MAXIMUM RATINGS

V _{CC} , RS+, RS- to GND	-0.3V to +30V	Continuous Power Dissipation (T _A = +70°C)	
OUT to GND	-0.3V to the lesser of (V _{CC} + 0.3V) or +15V	8-Pin μMAX (derate 4.1mW/°C above +70°C)	330mW
CIN1, CIN2, RESET to GND	-0.3V to the lesser of (V _{CC} + 0.3V) or +12V	8-Pin SO (derate 5.9mW/°C above +70°C)	471mW
Differential Input Voltage (V _{RS+} - V _{RS-})	±0.3V	10-Pin μMAX (derate 5.6mW/°C above +70°C)	444mW
COUT1, COUT2 to GND	-0.3V to +6.0V	14-Pin SO (derate 8.3mW/°C above +70°C)	667mW
Current into Any Pin	±10mA	Operating Temperature Range	-40°C to +85°C
		Junction Temperature	+150°C
		Storage Temperature Range	-65°C to +150°C
		Lead Temperature (soldering, 10s)	+300°C

Stresses beyond those listed under "Absolute Maximum Ratings" may cause permanent damage to the device. These are stress ratings only, and functional operation of the device at these or any other conditions beyond those indicated in the operational sections of the specifications is not implied. Exposure to absolute maximum rating conditions for extended periods may affect device reliability.

ELECTRICAL CHARACTERISTICS

(V_{CC} = +2.7V to +28V, V_{RS+} = 0 to +28V, V_{SENSE} = 0, V_{RESET} = 0, R_{LOAD} = 1MΩ, T_A = T_{MIN} to T_{MAX}, unless otherwise noted. Typical values are at T_A = +25°C.) (Note 1)

PARAMETER	SYMBOL	CONDITIONS	MIN	TYP	MAX	UNITS
Operating Voltage Range (Note 2)	V _{CC}		2.7		28	V
Common-Mode Input Range (Note 3)	V _{CMR}		0		28	V
Common-Mode Rejection	CMR	V _{RS+} > 2V		85		dB
Supply Current	I _{CC}	V _{RS+} > 2V, V _{SENSE} = 5mV		50	100	μA
Leakage Current	I _{RS+} , I _{RS-}	V _{CC} = 0		±0.015	±0.5	μA
Input Bias Current	I _{RS+}	V _{RS+} > 2V	0		2.5	μA
		V _{RS+} ≤ 2V	-25		2.0	
	I _{RS-}	V _{RS+} > 2V	0		4	
		V _{RS+} ≤ 2V	-50		4	
Full-Scale Sense Voltage (Note 4)	V _{SENSE}	Gain = +20V/V, +50V/V	150	170		mV
		Gain = +100V/V	100	120		
Full-Scale Accuracy (Note 5)		V _{SENSE} = 100mV, V _{CC} = 12V, V _{RS+} = 12V, T _A = +25°C		±0.66	±5.5	%
Total OUT Voltage Error (Note 5)		V _{SENSE} = 100mV (Note 6)	V _{CC} = 12V, V _{RS+} = 12V, T _A = T _{MIN} to T _{MAX}		±7.5	%
			V _{CC} = 28V, V _{RS+} = 28V, T _A = T _{MIN} to T _{MAX}	±0.55	±7.5	
			V _{CC} = 12V, V _{RS+} = 0.1V	±5.0		
		V _{SENSE} = 6.25mV, V _{CC} = 12V, V _{RS+} = 12V (Note 7)	±5.0			
OUT Voltage Low	V _{OUT}	V _{CC} = 2.7V	I _{OUT} = 10μA	2.5		mV
			I _{OUT} = 100μA	8.5	65	
OUT Voltage High	V _{CC} - V _{OH}	V _{CC} = 2.7V, I _{OUT} = -500μA			0.25	V

Low-Cost, Micropower, High-Side Current-Sense Amplifier + Comparator + Reference ICs

MAX4373/MAX4374/MAX4375

ELECTRICAL CHARACTERISTICS (continued)

(V_{CC} = +2.7V to +28V, V_{RS+} = 0 to +28V, V_{SENSE} = 0, V_{RESET} = 0, R_{LOAD} = 1MΩ, T_A = T_{MIN} to T_{MAX}, unless otherwise noted. Typical values are at T_A = +25°C.) (Note 1)

PARAMETER	SYMBOL	CONDITIONS		MIN	TYP	MAX	UNITS
-3dB Bandwidth	BW	V _{RS+} = 12V, V _{CC} = 12V, C _{LOAD} = 10pF	V _{SENSE} = 100mV, Gain = +20V/V		200		kHz
			V _{SENSE} = 100mV, Gain = +50V/V		120		
			V _{SENSE} = 100mV, Gain = +100V/V		110		
			V _{SENSE} = 6.25mV		50		
Gain	A _v	MAX437_T			+20		V/V
		MAX437_F			+50		
		MAX437_H			+100		
Gain Accuracy	ΔA _v	V _{SENSE} = 20mV to 150mV; V _{CC} = 12V; V _{RS+} = 12V; Gain = 20, 50	T _A = +25°C		±0.64	±5.2	%
			T _A = -40°C to +85°C			±7.2	
		V _{SENSE} = 20mV to 100mV, V _{CC} = 12V; V _{RS+} = 12V, Gain = 100	T _A = +25°C		±0.62	±5.0	
			T _A = -40°C to +85°C			±7.2	
OUT Settling Time to 1% of Final Value		Gain = +20V/V, V _{CC} = 12V, V _{RS+} = 12V, C _{LOAD} = 10pF	V _{SENSE} = 6.25mV to 100mV		20		μs
			V _{SENSE} = 100mV to 6.25mV		20		
Capacitive Load Stability		No sustained oscillations			1000		pF
OUT Output Resistance	R _{OUT}	V _{SENSE} = 100mV			1.5		Ω
Power-Supply Rejection	PSR	V _{OUT} = 2V, V _{RS+} > 2V		72	87		dB
Power-Up Time to 1% of Final Value		V _{SENSE} = 100mV, C _{LOAD} = 10pF, V _{CC} = 12V, V _{RS+} = 12V			0.5		ms
Saturation Recovery Time (Note 8)		V _{CC} = 12V, V _{RS+} = 12V, C _{LOAD} = 10pF			0.1		ms
COMPARATOR (Note 9)							
Comparator Threshold				580	600	618	mV
Comparator Hysteresis					-9		mV
Input Bias Current	I _B				±2.2	±15	nA
Propagation Delay		C _L = 10pF, R _L = 10kΩ pull-up to 5V, 5mV of overdrive			4		μs
Output Low Voltage	V _{OL}	I _{SINK} = 1mA				0.6	V

Low-Cost, Micropower, High-Side Current-Sense Amplifier + Comparator + Reference ICs

ELECTRICAL CHARACTERISTICS (continued)

($V_{CC} = +2.7V$ to $+28V$, $V_{RS+} = 0$ to $+28V$, $V_{SENSE} = 0$, $V_{\overline{RESET}} = 0$, $R_{LOAD} = 1M\Omega$, $T_A = T_{MIN}$ to T_{MAX} , unless otherwise noted. Typical values are at $T_A = +25^\circ C$.) (Note 1)

PARAMETER	SYMBOL	CONDITIONS	MIN	TYP	MAX	UNITS
Output High Leakage Current		$V_{CC} = 28V$, $V_{PULL-UP} = 5V$ (Note 10)			1	μA
\overline{RESET} Input High Voltage	V_{IH}		2.0			V
\overline{RESET} Input Low Voltage	V_{IL}				0.8	V
Logic Input Current	I_{IL} , I_{IH}	$V_{IL} = 0$, $V_{IH} = 5.5V$, $V_{CC} = 28V$	-0.5		0.5	μA
Minimum \overline{RESET} Pulse Width	t_{RPW}			1.5		μs
\overline{RESET} Propagation Delay	t_{RPD}			3		μs

- Note 1:** All devices are 100% production tested at $T_A = +25^\circ C$. All temperature limits are guaranteed by design.
- Note 2:** Guaranteed by PSR test.
- Note 3:** Guaranteed by OUT Voltage Error test.
- Note 4:** Guaranteed by Gain Accuracy test. Output voltage is internally clamped not to exceed 12V.
- Note 5:** Total OUT Voltage Error and Full-Scale Accuracy are the sum of gain and offset voltage errors.
- Note 6:** Measured at $I_{OUT} = -500\mu A$ ($R_{LOAD} = 4k\Omega$ for gain of $+20V/V$, $R_{LOAD} = 10k\Omega$ for gain of $+50V/V$, $R_{LOAD} = 20k\Omega$ for gain of $+100V/V$).
- Note 7:** $+6.25mV = 1/16$ of $+100mV$ full-scale voltage.
- Note 8:** The device will not experience phase reversal when overdriven.
- Note 9:** All comparator tests are done with $V_{RS+} = +12V$.
- Note 10:** $V_{PULL-UP}$ is defined as an externally applied voltage through a resistor to pull up the comparator output.

Typical Operating Characteristics

($V_{RS+} = +12V$, $V_{CC} = +12V$, $R_{LOAD} = 1M\Omega$, $V_{\overline{RESET}} = 0$, $V_{SENSE} = 100mV$, $V_{PULL-UP} = +5V$, $R_{PULL-UP} = 10k\Omega$, $T_A = +25^\circ C$, unless otherwise noted.)

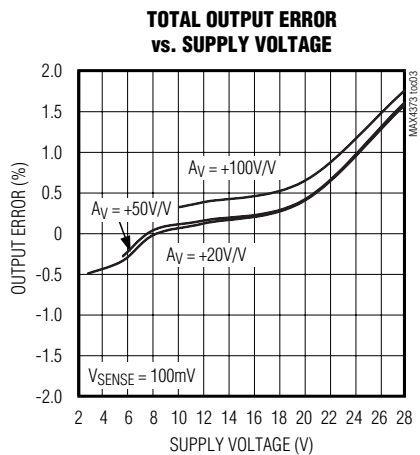
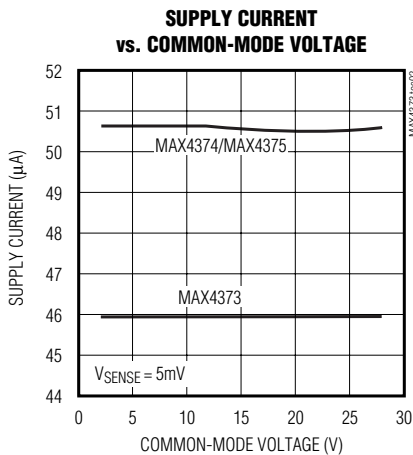
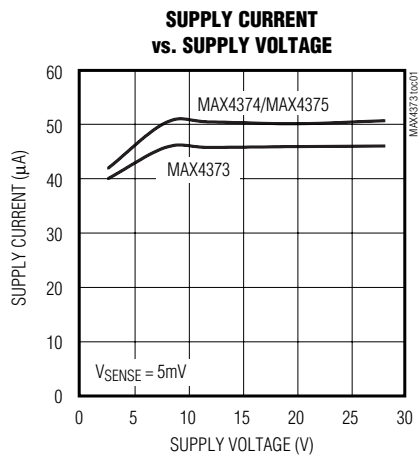

Low-Cost, Micropower, High-Side Current-Sense Amplifier + Comparator + Reference ICs

MAX4373/MAX4374/MAX4375

Typical Operating Characteristics (continued)

($V_{RS+} = +12V$, $V_{CC} = +12V$, $R_{LOAD} = 1M\Omega$, $V_{RESET} = 0$, $V_{SENSE} = 100mV$, $V_{PULL-UP} = +5V$, $R_{PULL-UP} = 10k\Omega$, $T_A = +25^\circ C$, unless otherwise noted.)

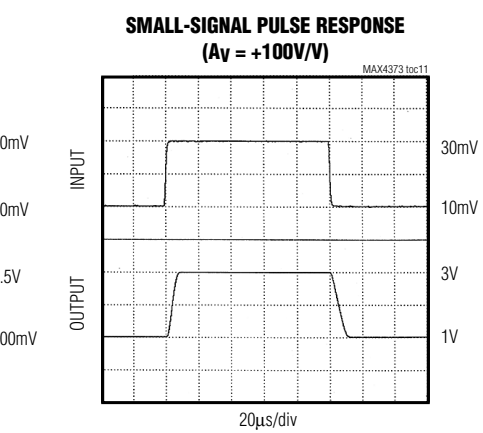
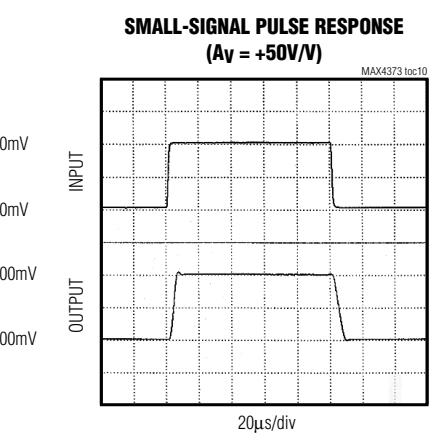
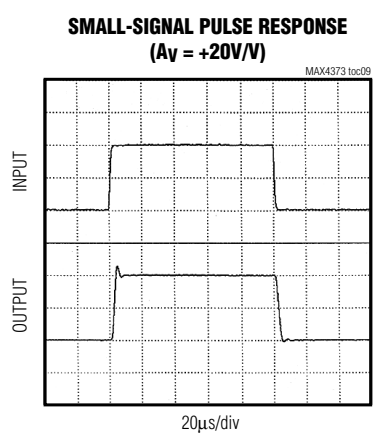
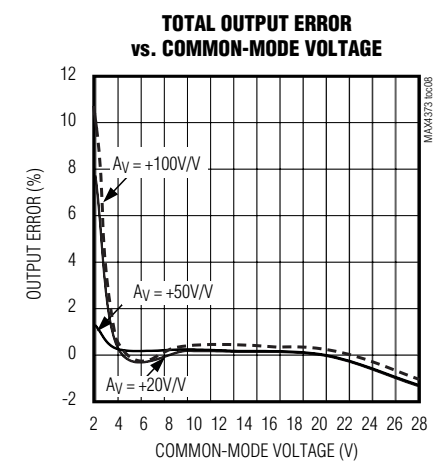
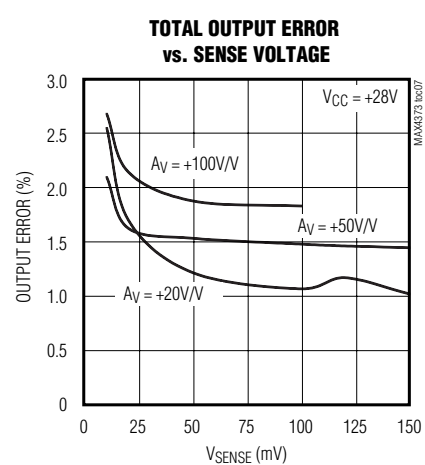
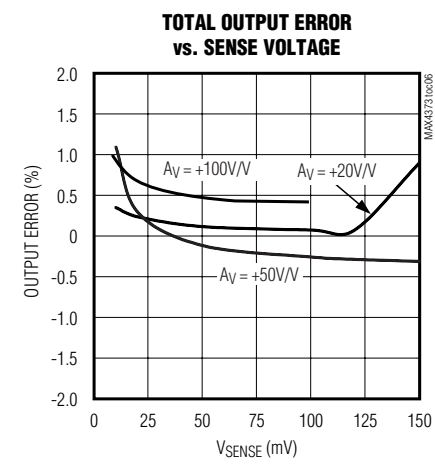
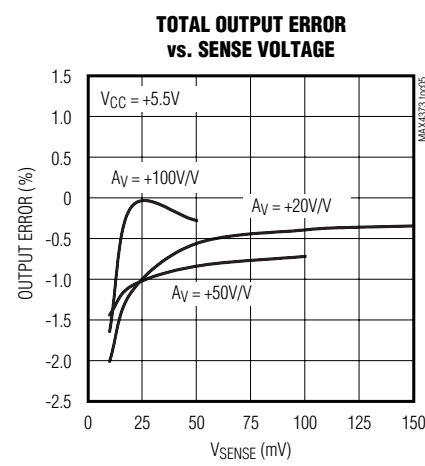
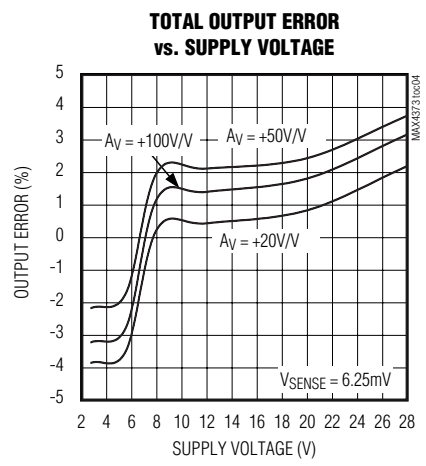

Low-Cost, Micropower, High-Side Current-Sense Amplifier + Comparator + Reference ICs

Typical Operating Characteristics (continued)

($V_{RS+} = +12V$, $V_{CC} = +12V$, $R_{LOAD} = 1M\Omega$, $V_{RESET} = 0$, $V_{SENSE} = 100mV$, $V_{PULL-UP} = +5V$, $R_{PULL-UP} = 10k\Omega$, $T_A = +25^\circ C$, unless otherwise noted.)

LARGE-SIGNAL PULSE RESPONSE
($A_V = +20V/V$)

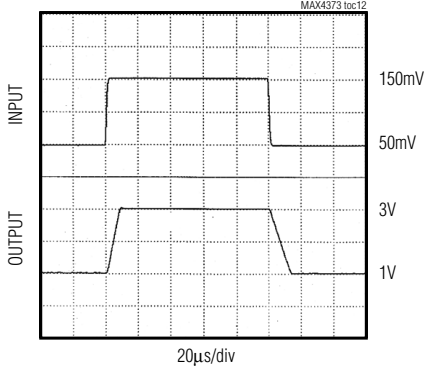

LARGE-SIGNAL PULSE RESPONSE
($A_V = +50V/V$)

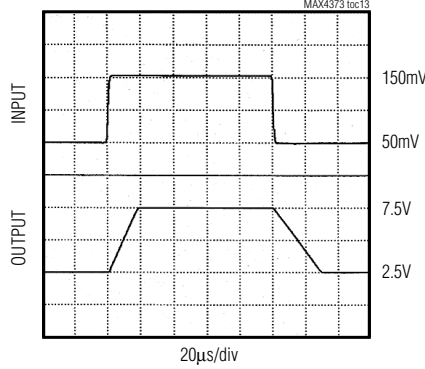

LARGE-SIGNAL PULSE RESPONSE
($A_V = +100V/V$)

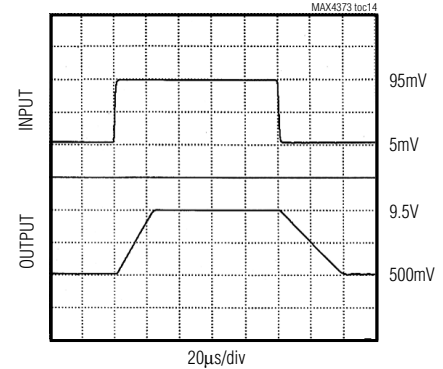

COMMON-MODE REJECTION vs. FREQUENCY

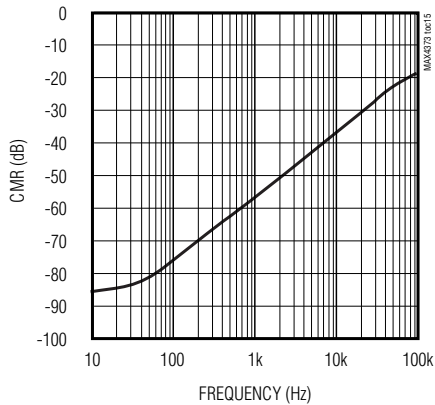

POWER-SUPPLY REJECTION vs. FREQUENCY

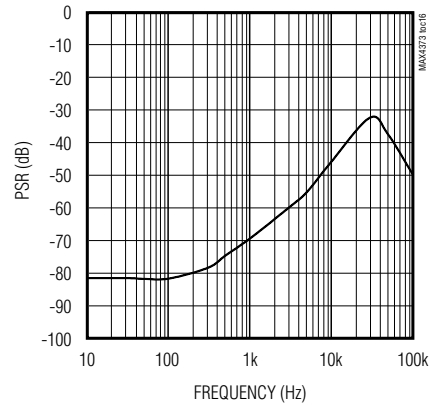

SMALL-SIGNAL GAIN vs. FREQUENCY

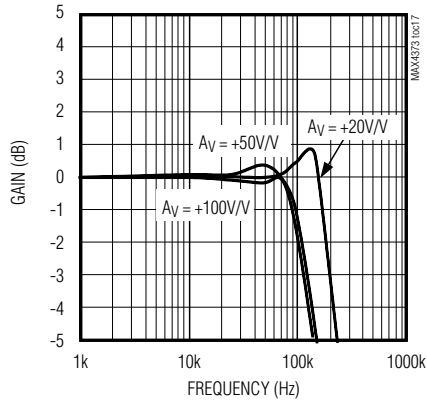

LARGE-SIGNAL GAIN vs. FREQUENCY

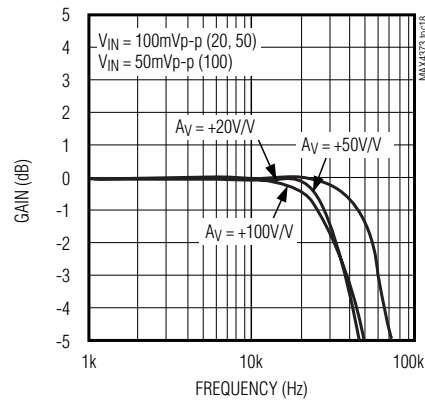

Low-Cost, Micropower, High-Side Current-Sense Amplifier + Comparator + Reference ICs

Typical Operating Characteristics (continued)

($V_{RS+} = +12V$, $V_{CC} = +12V$, $R_{LOAD} = 1M\Omega$, $V_{RESET} = 0$, $V_{SENSE} = 100mV$, $V_{PULL-UP} = +5V$, $R_{PULL-UP} = 10k\Omega$, $T_A = +25^\circ C$, unless otherwise noted.)

MAX4373/MAX4374/MAX4375

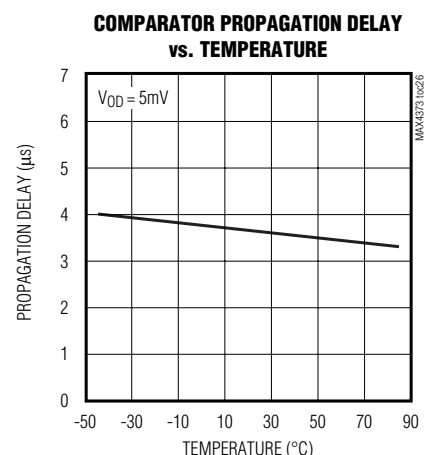
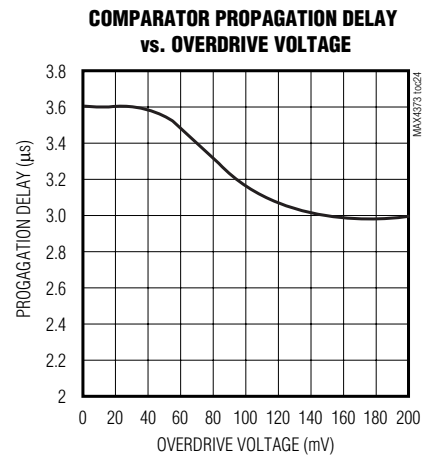
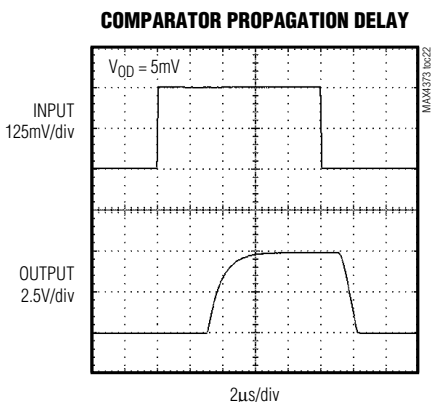
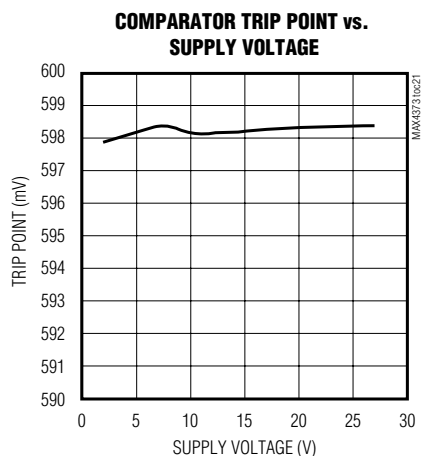
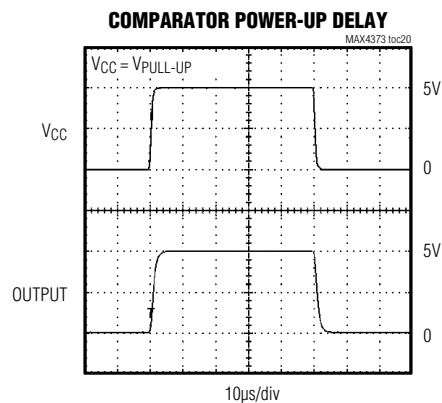
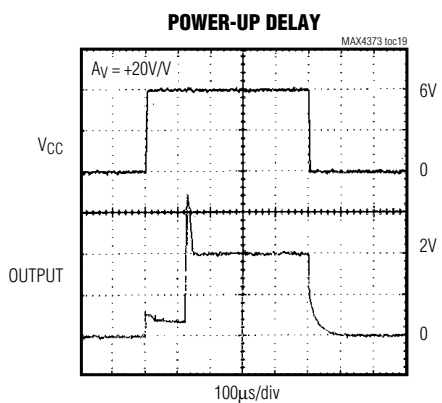

Low-Cost, Micropower, High-Side Current-Sense Amplifier + Comparator + Reference ICs

Typical Operating Characteristics (continued)

($V_{RS+} = +12V$, $V_{CC} = +12V$, $R_{LOAD} = 1M\Omega$, $V_{RESET} = 0$, $V_{SENSE} = 100mV$, $V_{PULL-UP} = +5V$, $R_{PULL-UP} = 10k\Omega$, $T_A = +25^\circ C$, unless otherwise noted.)

COMPARATOR RESET VOLTAGE vs. SUPPLY VOLTAGE

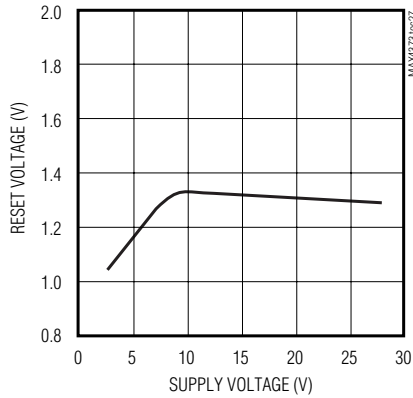

COMPARATOR V_{OL} vs. I_{SINK}

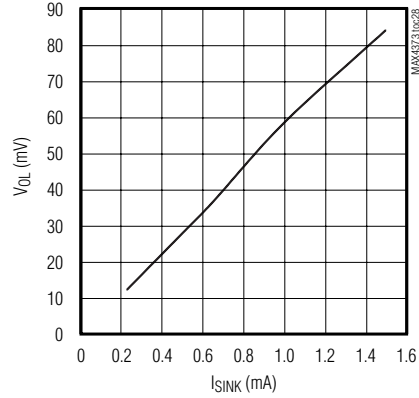

COMPARATOR AC RESPONSE

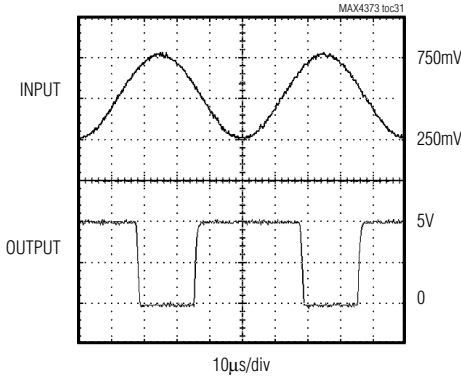

SUPPLY CURRENT vs. TEMPERATURE

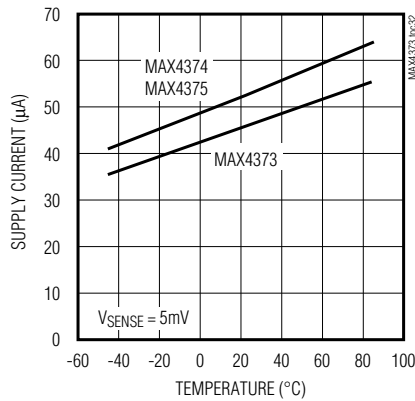

TOTAL OUTPUT ERROR vs. TEMPERATURE

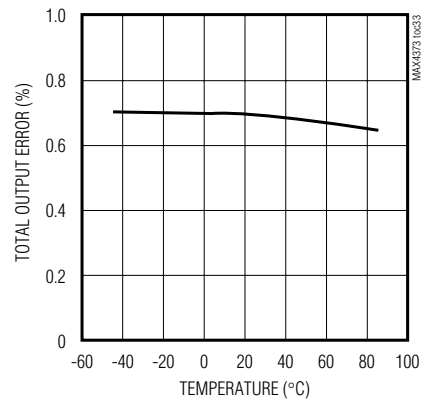

GAIN ACCURACY vs. TEMPERATURE

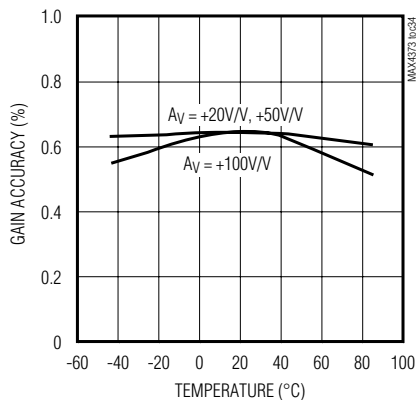

COMPARATOR TRIP POINT vs. TEMPERATURE

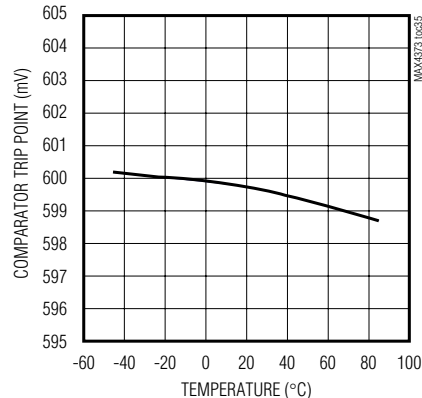

Low-Cost, Micropower, High-Side Current-Sense Amplifier + Comparator + Reference ICs

MAX4373/MAX4374/MAX4375

Pin Description

PIN			NAME	FUNCTION
MAX4373	MAX4374/MAX4375			
μ MAX/SO	μ MAX	SO		
1	1	1	V _{CC}	Supply Voltage Input
2	2	2	OUT	Voltage Output. V _{OUT} is proportional to V _{SENSE} (V _{RS+} - V _{RS-}).
3	3	4	CIN1	Comparator Input 1. Positive input of an internal comparator. The negative terminal is connected to a 0.6V internal reference.
—	4	5	CIN2	Comparator Input 2. Terminal of a second internal comparator. The positive terminal for the MAX4374 and the negative terminal for the MAX4375. The other terminal is connected to a 0.6V internal reference.
4	5	7	GND	Ground
5	6	8	$\overline{\text{RESET}}$	Reset Input. Resets the output latch of the comparator at CIN1.
6	8	11	COU1	Open-Drain Comparator Output. Latching output of the comparator controlled by CIN1. Connect $\overline{\text{RESET}}$ to GND to disable the latch.
—	7	10	COU2	Open-Drain Comparator Output. Output of the second unlatched internal comparator.
7	9	13	RS-	Load-Side Connection for the External Sense Resistor
8	10	14	RS+	Power Connection to the External Sense Resistor
—	—	3, 6, 9, 12	N.C.	No Connection. Not internally connected.

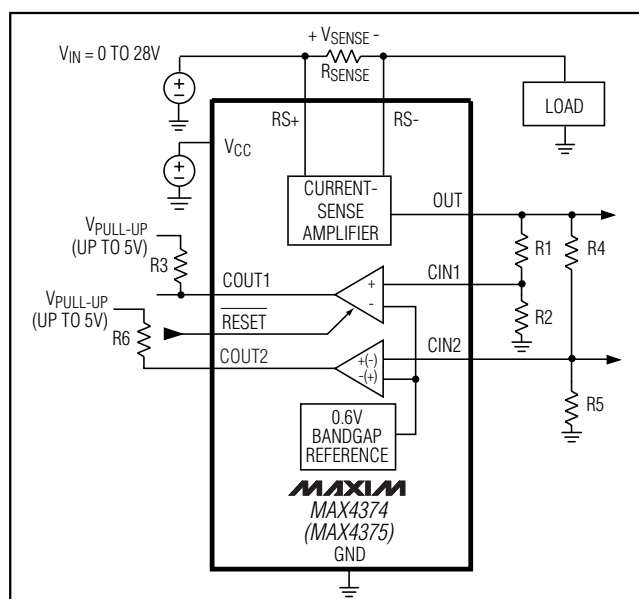

Figure 1. Functional Diagram

Detailed Description

The MAX4373 high-side current-sense supervisor features a high-side current-sense amplifier, bandgap reference, and comparator with latching output to monitor a supply for an overcurrent condition (Figure 1). The latching output allows the comparator to shut down a power supply without oscillations. The MAX4374/MAX4375 offer an additional comparator to allow window detection of the current.

Current-Sense Amplifier

The internal current-sense amplifier features a 0V to +28V input common-mode range that is independent of the supply voltage. With this feature, the device can monitor the output current of a battery in deep discharge and also high-side current-sensing voltages exceeding V_{CC}.

The current-sense amplifier is also suitable for low-side current sensing. However, the total output voltage error will increase when V_{RS+} falls below 2V, as shown in the *Electrical Characteristics* and *Typical Operating Characteristics*.

Low-Cost, Micropower, High-Side Current-Sense Amplifier + Comparator + Reference ICs

Internal Comparator(s)

The MAX4373/MAX4374/MAX4375 contain an open-drain output comparator for current limiting. The comparator's negative terminal is connected to the internal 600mV reference. The positive terminal is accessible at CIN1. When RESET is high, the internal latch is active, and once CIN1 rises above 600mV, the output latches into the open state. Pulsing RESET low for 1.5μs resets the latch, and holding RESET low makes the latch transparent.

The MAX4374/MAX4375 contain an additional open-drain comparator. The negative terminal of the MAX4374's additional comparator and the positive terminal of the MAX4375's additional comparator are connected to the internal 600mV reference as shown in Figure 1. The positive terminal of the MAX4374's additional comparator and the negative terminal of the MAX4375's additional comparator are accessible at CIN2.

Applications Information

Recommended Component Values

Ideally, the maximum load current will develop the full-scale sense voltage across the current-sense resistor. Choose the gain version needed to yield the maximum output voltage required for the application:

$$V_{OUT} = V_{SENSE} \times A_V$$

where V_{SENSE} is the full-scale sense voltage, 150mV for gains of +20V/V and +50V/V or 100mV for a gain of +100V/V. A_V is the gain of the device. The minimum supply voltage is $V_{OUT} + 0.25V$. Note that the output for the gain of +100V/V is internally clamped at 12V. Calculate the maximum value for R_{SENSE} so that the differential voltage across RS+ and RS- does not exceed the full-scale sense voltage:

$$R_{SENSE(MAX)} = \frac{V_{SENSE(MAX)}}{I_{LOAD}}$$

Choose the highest value resistance possible to maximize V_{SENSE} and thus minimize total output error.

In applications monitoring high current, ensure that R_{SENSE} is able to dissipate its own I^2R loss. If the resistor's power dissipation is exceeded, its value may drift or it may fail altogether, causing a differential voltage across the terminals in excess of the absolute maximum ratings. Use resistors specified for current-sensing applications.

Overcurrent Protection Circuit

The overcurrent protection circuit, shown in Figure 2, uses the MAX4373 to control an external P-channel

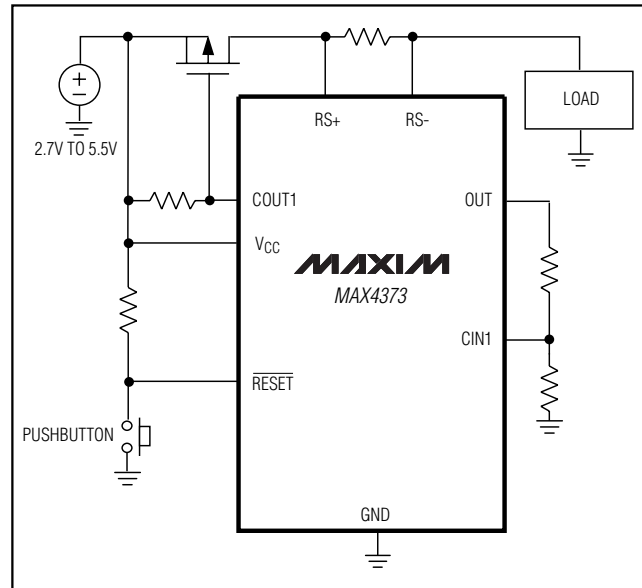

Figure 2. MAX4373 Overcurrent Protection Circuit

MOSFET. The MOSFET controlled by the MAX4373 opens the current path under overload conditions. The latched output of the MAX4373's comparator prevents the circuit from oscillating, and the pushbutton resets the current path after an overcurrent condition.

Window Detection Circuit

Figure 3 shows a simple circuit suitable for window detection. Let I_{OVER} be the minimum load current (I_{LOAD}) required to cause a low state at COUT2, and let I_{UNDER} be the maximum load current required to cause a high state at COUT1:

$$I_{UNDER} = \frac{V_{REF}}{R_{SENSE} \times A_V} \left(\frac{R4 + R5}{R5} \right)$$

and

$$I_{OVER} = \frac{V_{REF}}{R_{SENSE} \times A_V} \left(\frac{R1 + R2}{R2} \right)$$

where A_V is the gain of the device and V_{REF} is the internal reference voltage (0.6V typ).

Connect COUT1 and COUT2; the resulting comparator output will be high when the current is inside the current window and low when the current is outside the window. The window is defined as load currents less than I_{OVER} and greater than I_{UNDER} .

Low-Cost, Micropower, High-Side Current-Sense Amplifier + Comparator + Reference ICs

MAX4373/MAX4374/MAX4375

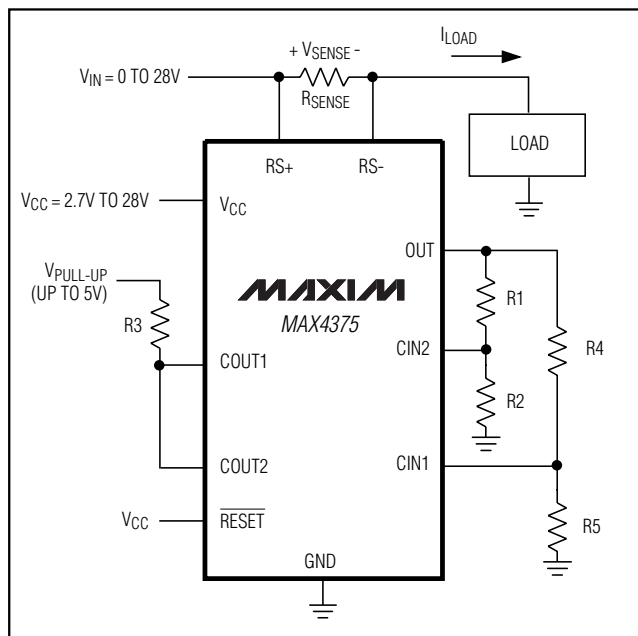

Figure 3. MAX4375 Window Detector

Ordering Information (continued)

PART	TEMP. RANGE	PIN-PACKAGE	GAIN (V/V)
MAX4374TEUB	-40°C to +85°C	10 μ MAX	+20
MAX4374TESD	-40°C to +85°C	14 SO	+20
MAX4374FEUB	-40°C to +85°C	10 μ MAX	+50
MAX4374FESD	-40°C to +85°C	14 SO	+50
MAX4374HEUB	-40°C to +85°C	10 μ MAX	+100
MAX4374HESD	-40°C to +85°C	14 SO	+100
MAX4375TEUB	-40°C to +85°C	10 μ MAX	+20
MAX4375TESD	-40°C to +85°C	14 SO	+20
MAX4375FEUB	-40°C to +85°C	10 μ MAX	+50
MAX4375FESD	-40°C to +85°C	14 SO	+50
MAX4375HEUB	-40°C to +85°C	10 μ MAX	+100
MAX4375HESD	-40°C to +85°C	14 SO	+100

Chip Information

TRANSISTOR COUNT: 390

SUBSTRATE CONNECTED TO GND

Pin Configurations

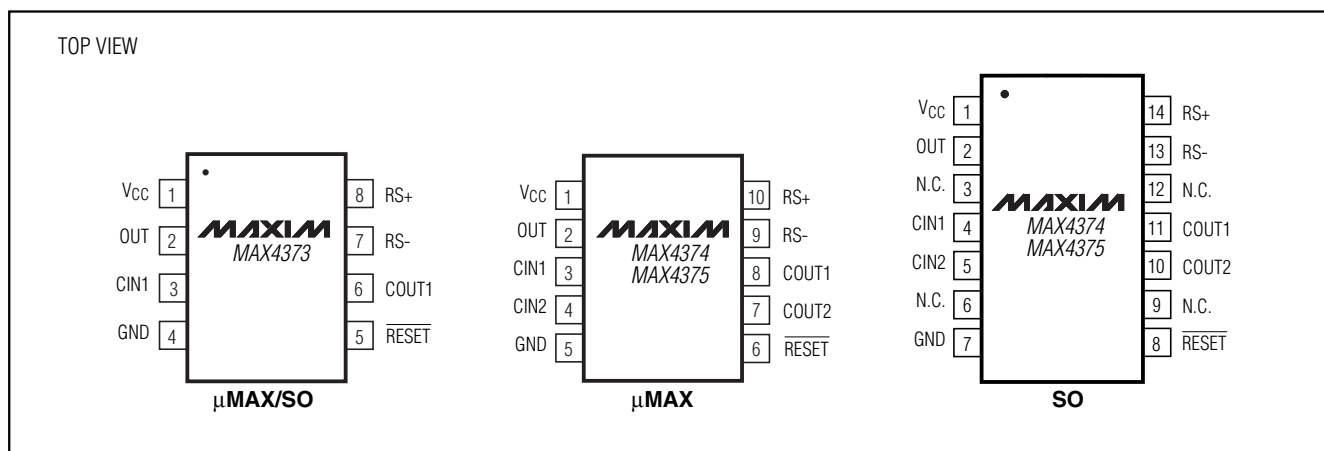

Low-Cost, Micropower, High-Side Current-Sense Amplifier + Comparator + Reference ICs

Package Information

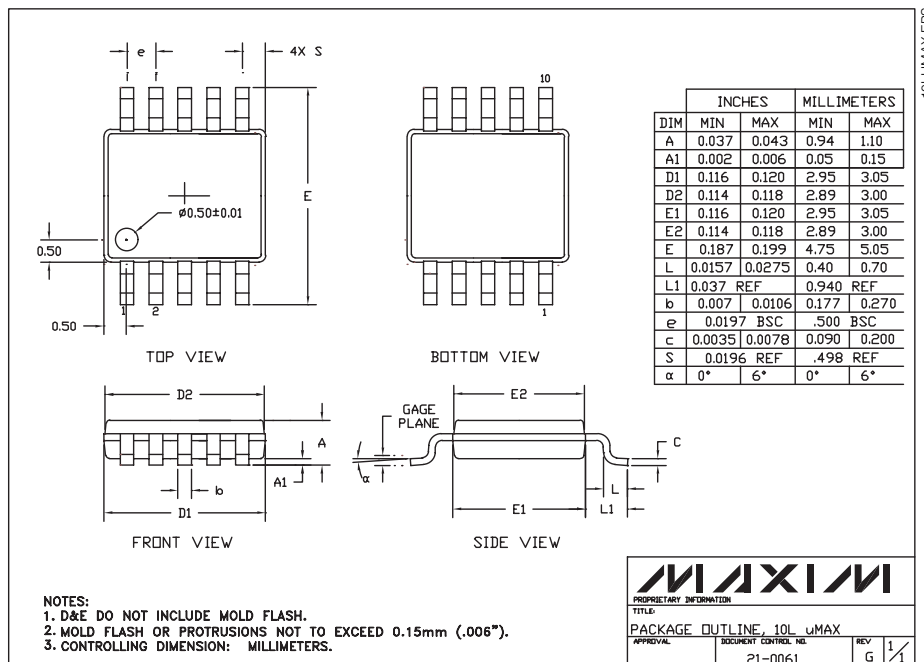
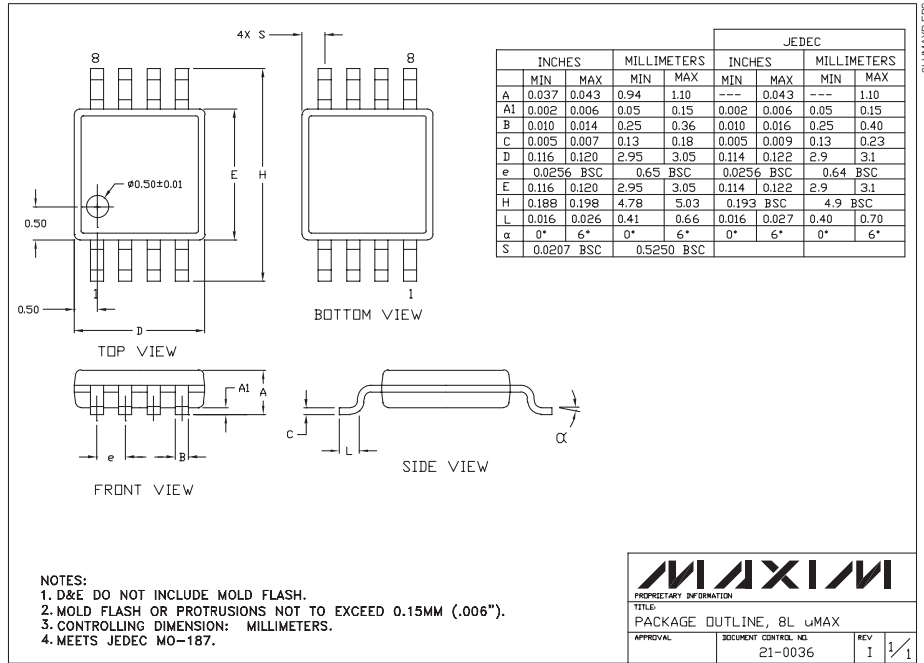

Maxim cannot assume responsibility for use of any circuitry other than circuitry entirely embodied in a Maxim product. No circuit patent licenses are implied. Maxim reserves the right to change the circuitry and specifications without notice at any time.

12 Maxim Integrated Products, 120 San Gabriel Drive, Sunnyvale, CA 94086 408-737-7600