

DAMPER + MODULATION DIODE FOR VIDEO

MAIN PRODUCT CHARACTERISTICS

	MODUL	DAMPER
$I_{F(AV)}$	3 A & 6 A	5 A & 6 A
V_{RRM}	600 V	1500 V
t_{rr}	50 ns	135 ns
$V_F(max)$	1.5 V	1.35 V

FEATURES AND BENEFITS

- FULL KIT IN ONE PACKAGE
- HIGH BREAKDOWN VOLTAGE CAPABILITY
- VERY FAST RECOVERY DIODE
- SPECIFIED TURN ON SWITCHING CHARACTERISTICS
- LOW STATIC AND PEAK FORWARD VOLTAGE DROP FOR LOW DISSIPATION
- INSULATED VERSION:
Insulated voltage = 2500 V_{RMS}
Capacitance = 7 pF
- PLANAR TECHNOLOGY ALLOWING HIGH QUALITY AND BEST ELECTRICAL CHARACTERISTICS
- OUTSTANDING PERFORMANCE OF WELL PROVEN DTV AS DAMPER AND TURBOSWITCH™ AS MODULATION

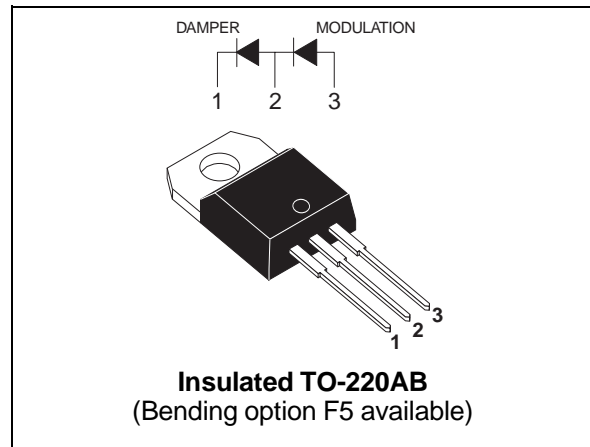

DESCRIPTION

High voltage semiconductor especially designed for horizontal deflection stage in standard and high resolution video display with E/W correction.

The insulated TO-220AB package includes both the DAMPER diode and the MODULATION diode. Assembled on automated line, it offers excellent insulating and dissipating characteristics, thanks to the internal ceramic insulation layer.

ABSOLUTE RATINGS (limiting values, per diode)

Symbol	Parameter		Value		Unit	
			MODUL	DAMPER		
V_{RRM}	Repetitive peak reverse voltage		600	1500	V	
I_{FSM}	Surge non repetitive forward current	tp = 10 ms sinusoidal	DMV16	50	50	A
			DMV32	60	75	
			DMV56	60	80	
T_{stg}	Storage temperature range		- 40 to + 150		°C	
T_j	Maximum operating junction temperature		150			

TURBOSWITCH is a trademark of STMicroelectronics

DMV series

THERMAL RESISTANCES

Symbol	Parameter	Value			Unit
		DMV16	DMV32	DMV56	
$R_{th(j-c)}$	Damper junction to case	5.3	4.8	3.6	°C/W
$R_{th(j-c)}$	Modulation junction to case	6.5	5.3	5.3	
$R_{th(c)}$	Coupling	0.2	0.2	0.2	
$R_{th(j-c)}$	Total as per full $I_{F(AV)}$ maximum ratings	6.0	5.1	4.5	

STATIC ELECTRICAL CHARACTERISTICS OF THE DAMPER DIODES

Symbol	Parameter	Test conditions		Value				Unit
				Tj = 25°C		Tj = 125°C		
				Typ.	Max.	Typ.	Max.	
V_F *	Forward voltage drop	$I_F = 5\text{ A}$	DMV16		1.6	1.0	1.5	V
		$I_F = 6\text{ A}$	DMV32		1.5	1.1	1.35	
		$I_F = 6\text{ A}$	DMV56		1.8	1.1	1.5	
I_R **	Reverse leakage current	$V_R = V_{RRM}$	DMV16		60	100	500	µA
			DMV32		100	100	1000	
			DMV56		100	100	1000	

Pulse test : * $t_p = 380\ \mu\text{s}$, $\delta < 2\%$

** $t_p = 5\text{ ms}$, $\delta < 2\%$

To evaluate the maximum conduction losses of the DAMPER diode use the following equations :

$$\text{DMV16: } P = 1.14 \times I_{F(AV)} + 0.072 \times I_{F(RMS)}^2$$

$$\text{DMV32: } P = 1.069 \times I_{F(AV)} + 0.047 \times I_{F(RMS)}^2$$

$$\text{DMV56: } P = 1.15 \times I_{F(AV)} + 0.059 \times I_{F(RMS)}^2$$

STATIC ELECTRICAL CHARACTERISTICS OF THE MODULATION DIODE

Symbol	Parameter	Test conditions		Value				Unit
				Tj = 25°C		Tj = 125°C		
				Typ.	Max.	Typ.	Max.	
V_F *	Forward voltage drop	$I_F = 3\text{ A}$	DMV16		1.4	1	1.3	V
		$I_F = 5\text{ A}$	DMV32		1.75	1.2	1.5	
		$I_F = 5\text{ A}$	DMV56		1.75	1.2	1.5	
I_R **	Reverse leakage current	$V_R = 480\text{ V}$	DMV16		20	150	500	µA
			DMV32		100	600	2000	
			DMV56		100	600	2000	

Pulse test : * $t_p = 380\ \mu\text{s}$, $\delta < 2\%$

** $t_p = 5\text{ ms}$, $\delta < 2\%$

To evaluate the maximum conduction losses of the MODULATION diode use the following equations :

$$\text{DMV16: } P = 1.06 \times I_{F(AV)} + 0.08 \times I_{F(RMS)}^2$$

$$\text{DMV32: } P = 1.15 \times I_{F(AV)} + 0.07 \times I_{F(RMS)}^2$$

$$\text{DMV56: } P = 1.15 \times I_{F(AV)} + 0.07 \times I_{F(RMS)}^2$$

RECOVERY CHARACTERISTICS OF THE DAMPER DIODE

Symbol	Parameter	Test conditions			Value		Unit
					Typ.	Max.	
t _{rr}	Reverse recovery time	I _F = 100mA I _R = 100mA I _{RR} = 10mA	T _j = 25°C	DMV16	1500		ns
				DMV32	850		
				DMV56	750		
t _{rr}	Reverse recovery time	I _F = 1A dI _F /dt = -50A/μs V _R = 30V	T _j = 25°C	DMV16	200	300	ns
				DMV32	130	175	
				DMV56	110	135	

RECOVERY CHARACTERISTICS OF THE MODULATION DIODE

Symbol	Parameter	Test conditions			Value		Unit
					Typ.	Max.	
t _{rr}	Reverse recovery time	I _F = 100mA I _R = 100mA I _{RR} = 10mA	T _j = 25°C	DMV16	210	650	ns
				DMV32	110	350	
				DMV56	110	350	
t _{rr}	Reverse recovery time	I _F = 1A dI _F /dt = -50A/μs V _R = 30V	T _j = 25°C	DMV16		95	ns
				DMV32		50	
				DMV56		50	

TURN-ON SWITCHING CHARACTERISTICS OF THE DAMPER DIODE

Symbol	Parameter	Test conditions			Value		Unit
					Typ.	Max.	
t _{fr}	Forward recovery time	I _F = 6A dI _F /dt = 80A/μs V _{FR} = 3V	T _j = 100°C	DMV16	350		ns
				DMV32	570		
				DMV56	350		
V _{FP}	Peak forward voltage	I _F = 6A dI _F /dt = 80A/μs	T _j = 100°C	DMV16	25	34	V
				DMV32	21	28	
				DMV56	19	26	

TURN-ON SWITCHING CHARACTERISTICS OF THE MODULATION DIODE

Symbol	Parameter	Test conditions			Value		Unit
					Typ.	Max.	
t _{fr}	Forward recovery time	I _F = 3A dI _F /dt = 80A/μs V _{FR} = 3V	T _j = 100°C	DMV16		500	ns
				DMV32		300	
				DMV56		300	
V _{FP}	Peak forward voltage	I _F = 3A dI _F /dt = 80A/μs	T _j = 100°C	DMV16		8	V
				DMV32		10	
				DMV56		10	

ORDERING INFORMATION

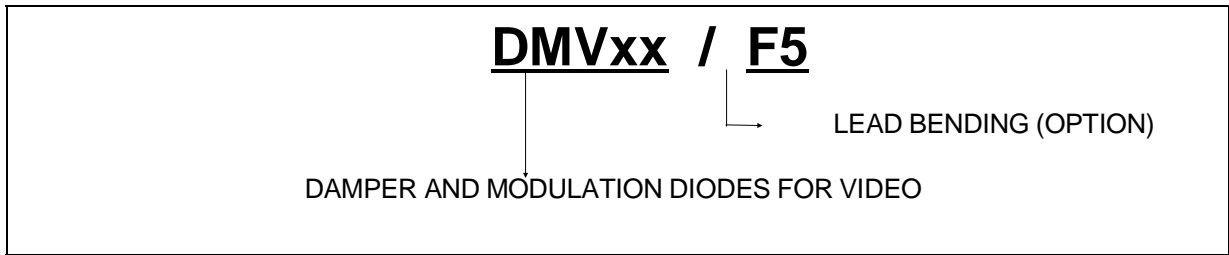

Fig. 1-1: Power dissipation versus peak forward current (triangular waveform, $\delta=0.45$) (damper diode.)

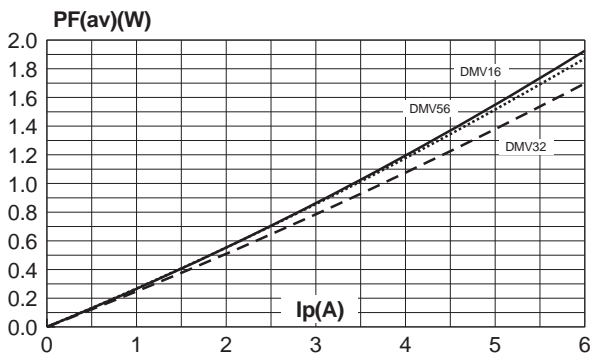

Fig. 1-2: Power dissipation versus peak forward current (triangular waveform, $\delta=0.45$) (modulation diode)

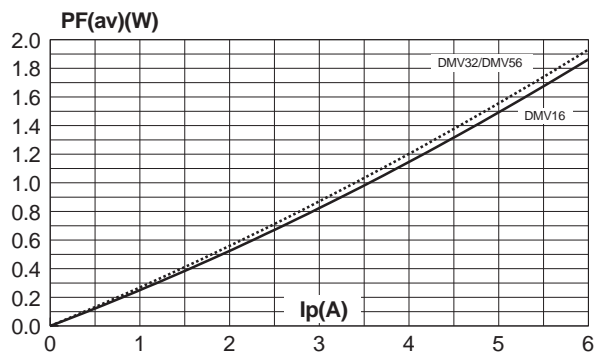

Fig. 2-1: Average forward current versus ambient temperature (damper diode).

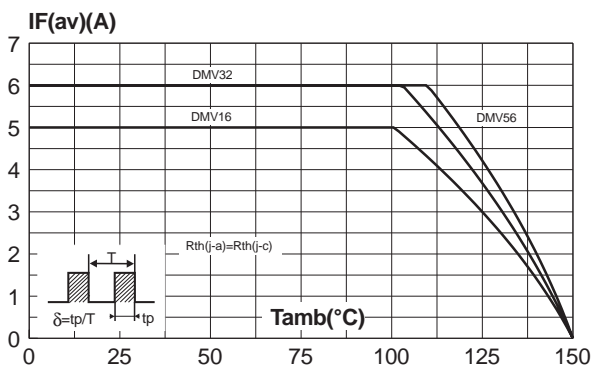

Fig. 2-2: Average forward current versus ambient temperature (modulation diode).

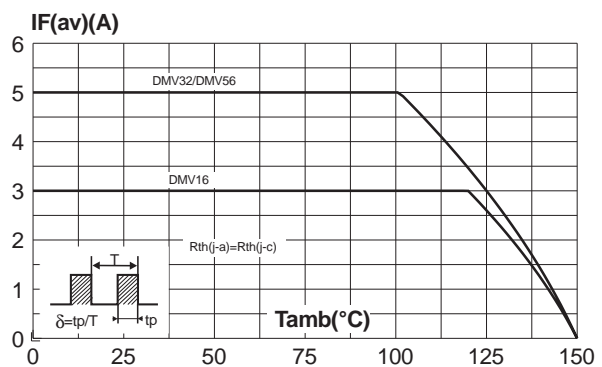

Fig. 3-1: Forward voltage drop versus forward current (damper diode) DMV16.

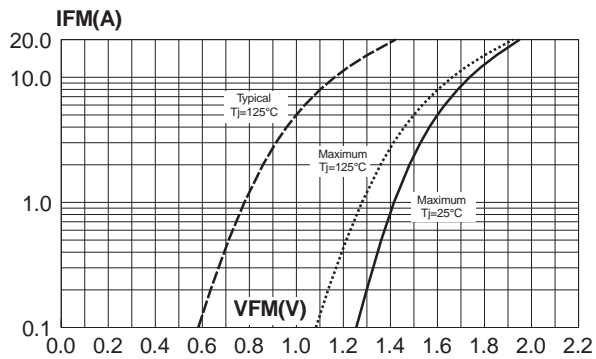

Fig. 3-2: Forward voltage drop versus forward current (damper diode) DMV32.

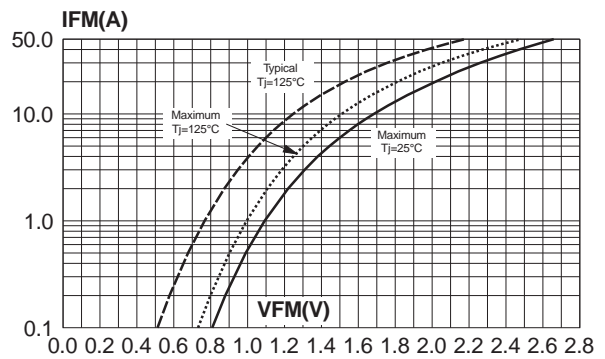

Fig. 3-3: Forward voltage drop versus forward current (damper diode) DMV56.

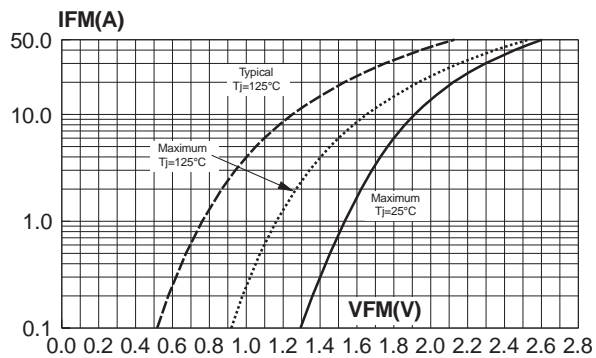

Fig. 3-4: Forward voltage drop versus forward current (modulation diode) DMV16.

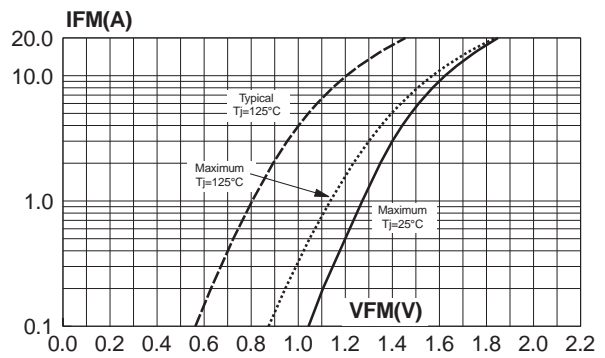

Fig. 3-5: Forward voltage drop versus forward current (modulation diode) DMV32 and DMV56.

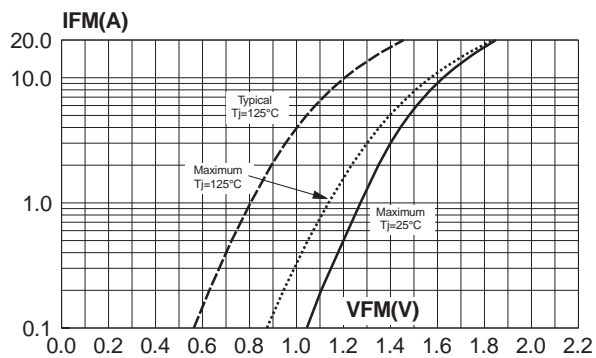
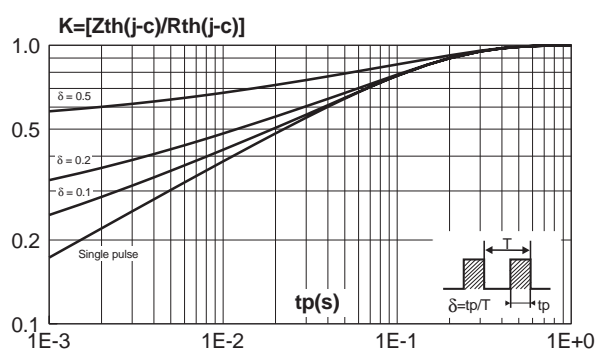

Fig. 4: Relative variation of thermal impedance junction to case versus pulse duration.



DMV series

Fig. 5-1: Non repetitive surge peak forward current versus overload duration (damper diode).

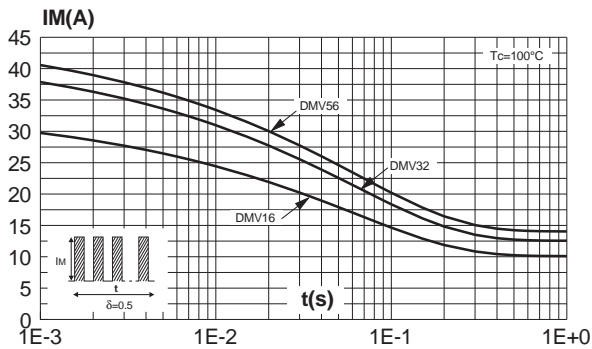

Fig. 5-2: Non repetitive surge peak forward current versus overload duration (modulation diode).

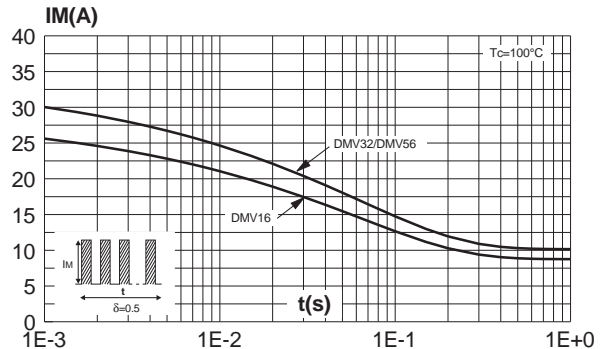

Fig. 6-1: Reverse recovery charges versus dI_F/dt (damper diode).

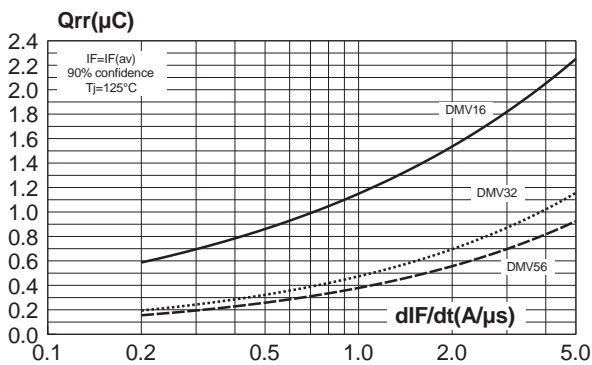

Fig. 6-2: Reverse recovery charges versus dI_F/dt (modulation diode).

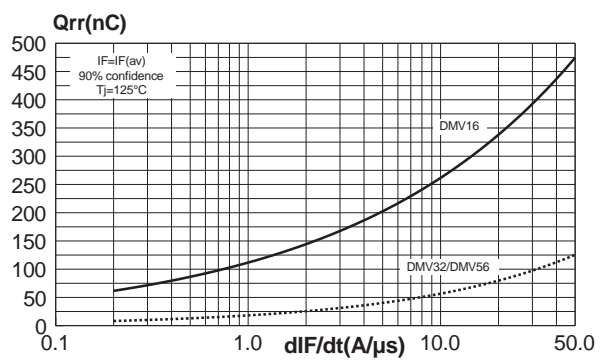

Fig. 7-1: Reverse recovery current versus dI_F/dt (damper diode).

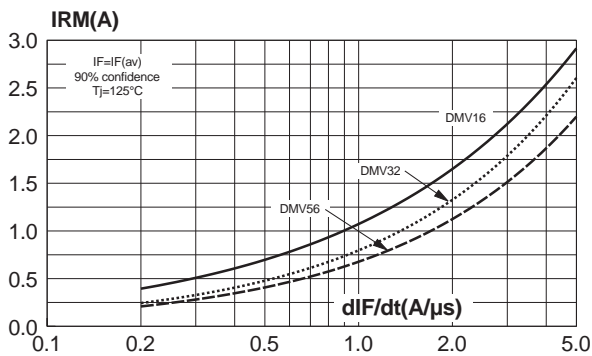

Fig. 7-2: Reverse recovery current versus dI_F/dt (modulation diode).

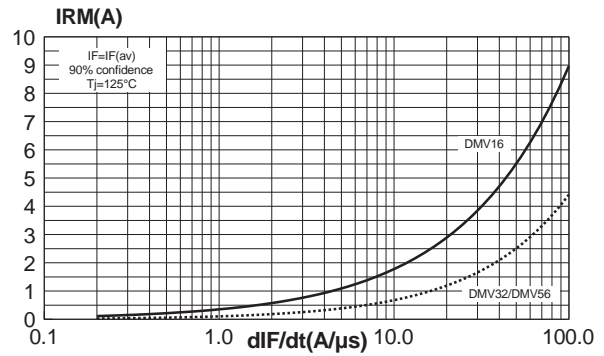

Fig. 8-1: Transient peak forward voltage versus dI_F/dt (damper diode).

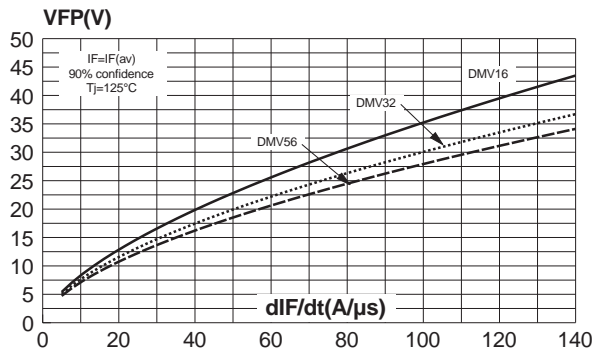

Fig. 8-2: Transient peak forward voltage versus dI_F/dt (modulation diode).

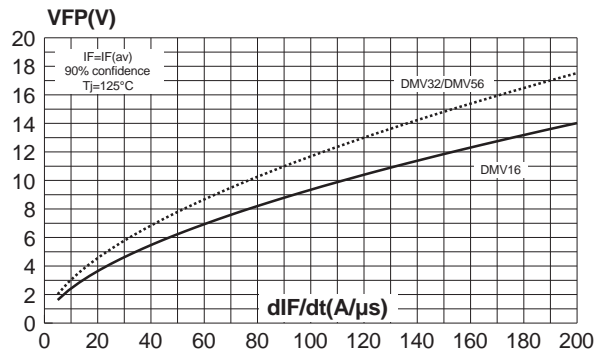

Fig. 9-1: Forward recovery time versus dI_F/dt (damper diode).

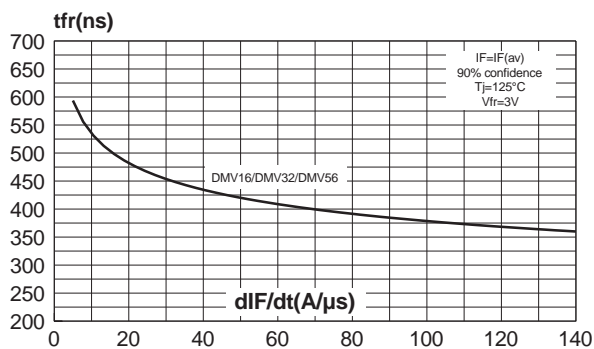

Fig. 9-2: Forward recovery time versus dI_F/dt (modulation diode).

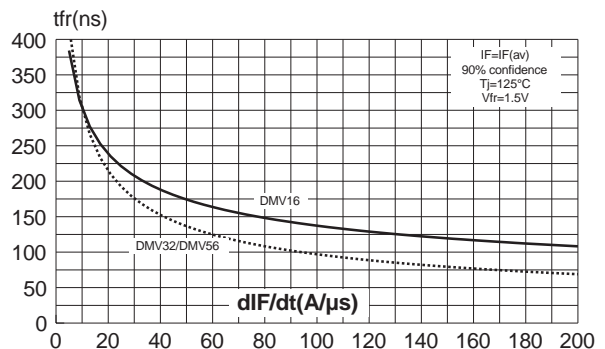

Fig. 10: Dynamic parameters versus junction temperature (damper & modulation diodes).

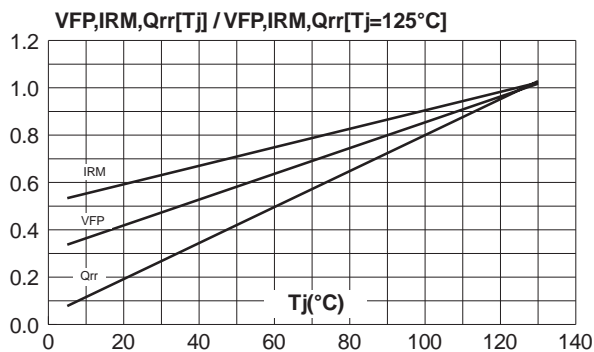
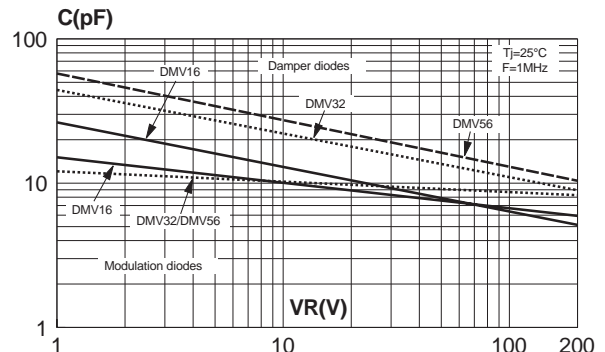

Fig. 11: Junction capacitance versus reverse voltage applied (typical values).



DMV series

PACKAGE MECHANICAL DATA TO-220AB F5 OPTION

REF.	DIMENSIONS			
	Millimeters		Inches	
	Min.	Max.	Min.	Max.
A	15.20	15.90	0.598	0.625
a1	24.16	26.90	0.951	1.059
a3	1.65	2.41	0.064	0.094
B	10.00	10.40	0.393	0.409
b1	0.61	0.88	0.024	0.034
b2	1.23	1.32	0.048	0.051
C	4.40	4.60	0.173	0.181
c1	0.49	0.70	0.019	0.027
c2	2.40	2.72	0.094	0.107
e	2.40	2.70	0.094	0.106
F	6.20	6.60	0.244	0.259
l	3.75	3.85	0.147	0.151
L	2.65	2.95	0.104	0.116
l2	1.14	1.70	0.044	0.066
l3	1.14	1.70	0.044	0.066
l4	15.80	16.80	0.622	0.661
	16.40 typ.		0.645 typ.	
M1	2.92	3.30	0.114	0.129
R1	1.40 typ.		0.055 typ.	
R2	1.40 typ.		0.055 typ.	

PRINTED CIRCUIT LAYOUT FOR F5 LAYOUT

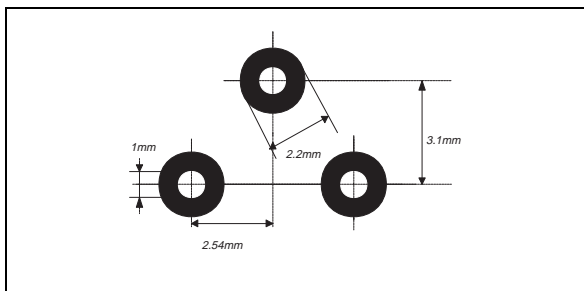

- cooling method: by conduction (c)
- Recommended torque value: 0.8 m.N.
- Maximum torque value: 1 m.N.

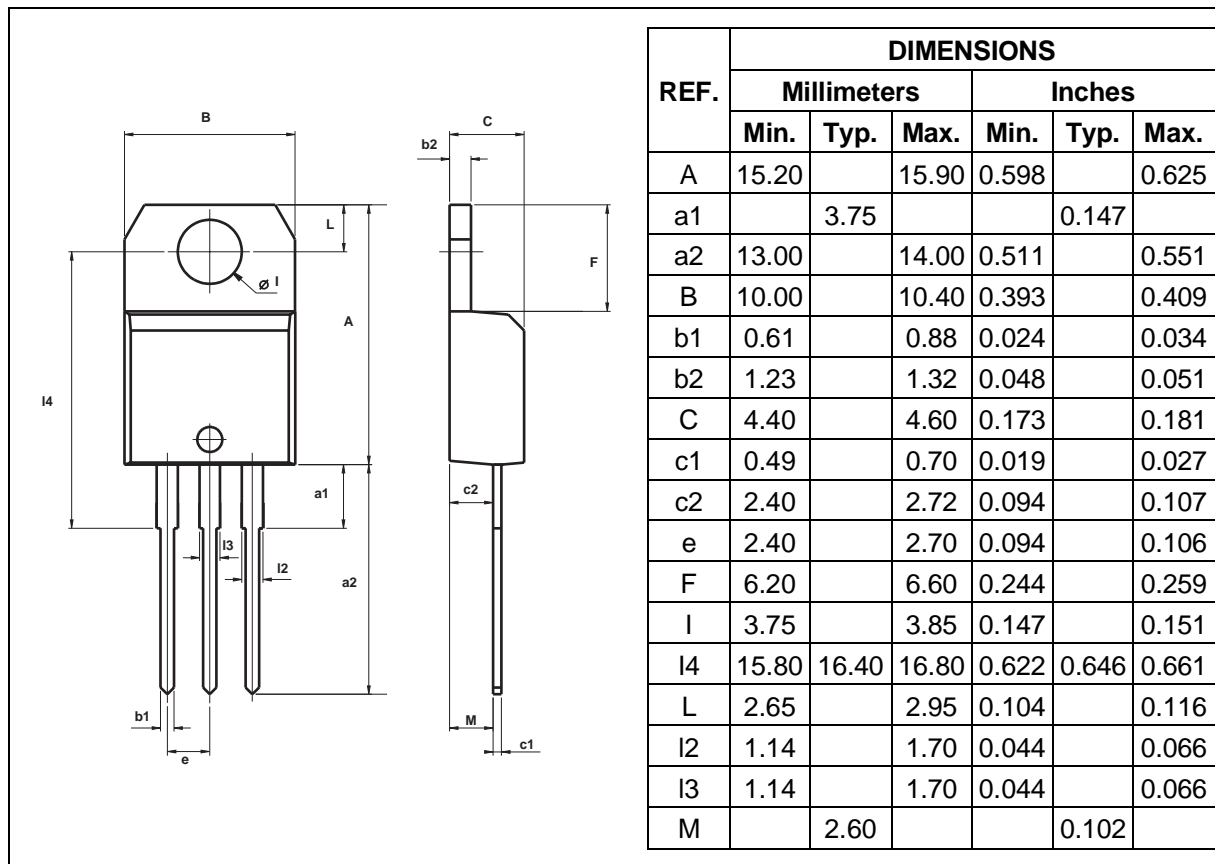
PACKAGE MECHANICAL DATA
 TO-220AB

- cooling method: by conduction (c)
- Recommended torque value: 0.8 m.N.
- Maximum torque value: 1 m.N.

Type	Marking	Package	Weight	Base qty	Delivery mode
DMV16 DMV16/F5	DMV16	TO-220AB	2.2 g.	50	Tube
DMV32 DMV32/F5	DMV32	TO-220AB	2.2 g.	50	Tube
DMV56 DMV56/F5	DMV56	TO-220AB	2.2 g.	50	Tube

- Epoxy meets UL94, V0

Information furnished is believed to be accurate and reliable. However, STMicroelectronics assumes no responsibility for the consequences of use of such information nor for any infringement of patents or other rights of third parties which may result from its use. No license is granted by implication or otherwise under any patent or patent rights of STMicroelectronics. Specifications mentioned in this publication are subject to change without notice. This publication supersedes and replaces all information previously supplied. STMicroelectronics products are not authorized for use as critical components in life support devices or systems without express written approval of STMicroelectronics.

The ST logo is a registered trademark of STMicroelectronics

© 1999 STMicroelectronics - Printed in Italy - All rights reserved.

STMicroelectronics GROUP OF COMPANIES

Australia - Brazil - China - Finland - France - Germany - Hong Kong - India - Italy - Japan - Malaysia
 Malta - Morocco - Singapore - Spain - Sweden - Switzerland - United Kingdom - U.S.A.

<http://www.st.com>